



Pressure | Temperature | Level | Force | Flow | Calibration

# Standard product portfolio



Smart in sensing



**Alexander Wiegand**  
Chairman and  
CEO, WIKA

## About us

The WIKA Group is a global market leader in pressure and temperature measurement. The company also sets the standard in the measurement of level, force and flow, and in calibration technology.

The broad portfolio of high-precision instruments, IIoT solutions and comprehensive services makes WIKA a strong and reliable partner for all the requirements of industrial measurement technology.

The family-run business, founded in 1946, has a global presence with 11,200 employees. This includes our own subsidiaries, production sites and development departments, such as the Innovation Center in Klingenberg. There alone, over 100 engineers work on smart sensing solutions that provide answers to global challenges. WIKA's unique experience and know-how make sensing technology smarter, add more value and prepare it for a sustainable future:

**Smart in sensing.**

# Contents

You will find more info on our industry-specific products on page 118.

## PRESSURE

Display	Pressure gauges	4
	Digital pressure gauges	12
Transmit	Process transmitters	14
	Pressure sensors	16
	Pressure gauges with output signal	19
Switch	Contact pressure gauges	21
	Pressure switches	23
Additional products and accessories	Diaphragm seal systems	26
	Valves and mounting accessories	27
	Electrical accessories	29

## TEMPERATURE

Display	Dial thermometers	30
	Digital indicators	34
Transmit + Record	Thermocouples	36
	Resistance thermometers	42
	Temperature transmitters	47
Switch	Temperature switches	48
	Thermometers with switch contacts	49
	Temperature controllers	50
Additional products and accessories	Thermowells / Protection tubes	51
	Accessories	53

## LEVEL

Display	Bypass level indicators	54
	External chambers	57
	Glass level gauges	58
Transmit	Submersible pressure sensors	60
	Continuous measurement with float	61
Switch	Float switches	66
	Optoelectronic switches	70
	Vibrating level switches	73

## FORCE

Compression force transducers	74
Tension/Compression force transducers	75
Bending/Shear beams	76
Load cells	77
Load pins	78
Ring force transducers, tension links	79
Special force transducers	80
Electronics	81

## FLOW

Primary flow elements	82
Flow switches	89

## IIOT SOLUTIONS

IIoT service	90
IIoT products	92

## CALIBRATION

Pressure	Digital pressure gauges	94
	Hand-helds, calibrators	95
	Precision pressure measuring instruments	97
	Pressure controllers	98
	Pressure balances	100
	Calibration software	103
Pressure generation	104	
Temperature	Reference thermometers	106
	Hand-helds	107
	Calibration baths	108
	Portable temperature calibrators	109
	Resistance thermometry bridges	110
Standard reference resistors, AC/DC	111	
Additional products and accessories	112	
Engineered solutions	113	

## SERVICE

Service	116
---------	-----

# Bourdon tube pressure gauges

## Copper alloy

These pressure gauges are suitable for liquid and gaseous media, so long as they are not highly viscous or crystallising and do not attack copper alloy parts. The scale ranges cover pressures from 0.6 ... 1,000 bar. These instruments are manufactured in accordance with the European standard EN837-1 (except for model 111.11 and 111.12 in NS 27).



**111.10, 111.12**  
Standard version

Nominal size	27, 40, 50, 63, 80, 100, 160 mm
Scale range	-1 ... 0 to 0 ... 400 bar
Accuracy class	2.5, 1.6 optional NS 27: 4.0
Data sheet	PM 01.01, PM 01.17



**111.11**  
Welding gauge ISO 5171

Nominal size	40, 50, 63 mm
Scale range	0 ... 0.6 to 0 ... 400 bar
Accuracy class	2.5
Data sheet	PM 01.03



**111.16, 111.26**  
Welding gauge ISO 5171

Nominal size	40, 50, 63 mm, model 111.26 also 80 mm
Scale range	-1 ... 0 to 0 ... 400 bar
Accuracy class	2.5
Data sheet	PM 01.10



**113.13**  
Plastic case, liquid filling

Nominal size	40, 50, 63 mm
Scale range	-1 ... 0 to 0 ... 400 bar
Accuracy class	2.5
Data sheet	PM 01.04



**214.11**  
Edgewise panel design

Nominal size	96 x 96, 72 x 72
Scale range	■ NS 96 x 96: 0 ... 0.6 to 0 ... 1,000 bar ■ NS 72 x 72: 0 ... 0.6 to 0 ... 400 bar
Accuracy class	1.6, 1.0
Data sheet	PM 02.07



**PG81, PG91**  
DirectDrive pressure gauge

Nominal size	36, 41 mm
Scale range	0 ... 6 to 0 ... 450 bar
Accuracy class	4.0
Data sheet	PM 01.50



**212.20**  
Stainless steel case

Nominal size	100, 160 mm
Scale range	-1 ... 0 to 0 ... 1,000 bar
Accuracy class	1.0
Data sheet	PM 02.01



**213.40**  
Heavy-duty version, case filling

Nominal size	63, 80, 100 mm
Scale range	-1 ... 0 to 0 ... 1,000 bar
Accuracy class	1.0, 1.6 (NS 63, 80)
Data sheet	PM 02.06



**113.53, 213.53**  
Stainless steel case, case filling

Nominal size	<ul style="list-style-type: none"> <li>■ 113.53: 40, 80, 100 mm</li> <li>■ 213.53: 50, 63, 100 mm</li> </ul>
Scale range	-1 ... 0 to 0 ... 600 bar (213.53: to 1,000 bar)
Accuracy class	113.53: 1.6 (NS 80, 100), 2.5 213.53: 1.0 (NS 63, 100), 1.6 (NS 50)
Data sheet	PM 01.08, PM 02.12

## Thermomanometers



**MFT**  
With capillaries, for pressure and temperature measurement

Nominal size	40, 42, 52 mm
Scale range	<ul style="list-style-type: none"> <li>■ Pressure: 0 ... 4 bar</li> <li>■ Temperature: 0 ... 120 °C</li> </ul>
Accuracy class	<ul style="list-style-type: none"> <li>■ Pressure: 2.5 (EN 837-1)</li> <li>■ Temperature: 2.5</li> </ul>
Data sheet	PM 01.20



**THM10**  
Eco version, for pressure and temperature measurement

Nominal size	63, 80 mm
Scale range	<ul style="list-style-type: none"> <li>■ Pressure: 0 ... 4 to 0 ... 10 bar</li> <li>■ Temperature: 0 ... 120 °C</li> </ul>
Connection location	Lower mount or back mount
Accuracy class	<ul style="list-style-type: none"> <li>■ Pressure: 2.5 (EN 837-1)</li> <li>■ Temperature: 2 (EN 13190)</li> </ul>
Data sheet	PM 01.24



**100.02**  
For pressure and temperature measurement

Nominal size	63, 80 mm
Scale range	<ul style="list-style-type: none"> <li>■ Pressure: 0 ... 1 to 0 ... 16 bar</li> <li>■ Temperature: 0 ... 100 to 0 ... 150 °C</li> </ul>
Connection location	Lower mount or back mount
Accuracy class	<ul style="list-style-type: none"> <li>■ Pressure: 2.5 (EN 837-1)</li> <li>■ Temperature: ±2.5</li> </ul>
Data sheet	PM 01.23

# Bourdon tube pressure gauges

## Stainless steel

The wetted parts of these pressure gauges are manufactured entirely from stainless steel. Thus they are suitable for gaseous and liquid aggressive media that are not highly viscous or crystallising, also in aggressive environments. They are suitable for scale ranges from 0 ... 0.6 to 0 ... 7,000 bar.

Depending on the pressure range and the instrument model, overload safety of to a maximum of 5 x full scale value is possible. To this point, the measurement accuracy is maintained. Liquid filling the case ensures a precise instrument display, even with high dynamic pressure loads and vibrations.

ERAC



**131.11**  
Compact version

Nominal size	40, 50, 63 mm
Scale range	<ul style="list-style-type: none"> <li>■ NS 40, 50: 0 ... 1 to 0 ... 600 bar</li> <li>■ NS 63: 0 ... 1 to 0 ... 1,000 bar</li> </ul>
Accuracy class	2.5
Ingress protection	IP54
Data sheet	PM 01.05

Ex ERAC



**232.50, 233.50**  
For the process industry,  
standard version

Nominal size	63, 100, 160 mm
Scale range	<ul style="list-style-type: none"> <li>■ NS 63: 0 ... 1 to 0 ... 1,000 bar</li> <li>■ NS 100: 0 ... 0.6 to 0 ... 1,000 bar</li> <li>■ NS 160: 0 ... 0.6 to 0 ... 1,600 bar</li> </ul>
Accuracy class	1.0 (NS 100, 160), 1.6 (NS 63)
Ingress protection	IP65
Data sheet	PM 02.02

Ex ERAC S



**232.30, 233.30**  
For the process industry,  
safety version

Nominal size	63, 100, 160 mm
Scale range	<ul style="list-style-type: none"> <li>■ NS 63: 0 ... 1 to 0 ... 1,000 bar</li> <li>■ NS 100: 0 ... 0.6 to 0 ... 1,000 bar</li> <li>■ NS 160: 0 ... 0.6 to 0 ... 1,600 bar</li> </ul>
Accuracy class	1.0 (NS 100, 160), 1.6 (NS 63)
Ingress protection	IP65
Data sheet	PM 02.04

Ex ERAC S



**232.36, 233.36**  
High overload safety to 4 times the  
full scale value, safety version

Nominal size	100, 160 mm
Scale range	0 ... 0.6 to 0 ... 40 bar
Overload safety	Up to 4 times the measuring range
Accuracy class	1.0
Data sheet	PM 02.15



**232.34, 233.34**  
Process pressure gauge XSEL<sup>®</sup>,  
safety version per ASME B40.100

Nominal size	4 1/2", 6"
Scale range	0 ... 0.6 bar to 0 ... 2,000 bar
Accuracy class	Grade 2A
Ingress protection	IP54, with liquid filling IP65
Data sheet	PM 02.10

# Test gauges

## For highest accuracy

Depending on the instrument model, accuracies of 0.1, 0.25 or 0.6 % of full scale value can be measured.

The pressure ranges cover from 0 ... 6 mbar to 0 ... 1,600 bar and are suitable for calibration tasks. For each of the pressure gauges specified here, a DAkkS calibration certificate can be provided.

EAC

**312.20**

Copper alloy, class 0.6

Nominal size	160 mm
Scale range	0 ... 0.6 to 0 ... 600 bar
Accuracy class	0.6
Ingress protection	IP54
Data sheet	PM 03.01

EAC

**332.50, 333.50**

Stainless steel, standard version, class 0.6

Nominal size	160 mm
Scale range	0 ... 0.6 to 0 ... 1,600 bar
Accuracy class	0.6
Ingress protection	IP65
Data sheet	PM 03.06

EAC (S)

**332.30, 333.30**

Stainless steel, safety version, class 0.6

Nominal size	160 mm
Scale range	0 ... 0.6 to 0 ... 1,600 bar
Accuracy class	0.6
Ingress protection	IP65
Data sheet	PM 03.05

EAC

**342.11**

From class 0.1, with transport case and acceptance test certificate

Nominal size	250 mm
Scale range	0 ... 1 to 0 ... 1,600 bar
Accuracy class	■ 0.1 for scale ranges < 400 bar ■ 0.25 for scale ranges ≥ 400 bar
Ingress protection	IP54
Data sheet	PM 03.03

EAC

**610.20, 630.20**

For low pressure ranges from 10 mbar, class 0.6

Nominal size	160 mm
Scale range	0 ... 10 to 0 ... 600 mbar
Accuracy class	0.6
Ingress protection	IP54
Data sheet	PM 06.09

# Diaphragm pressure gauges

The application areas for diaphragm pressure gauges are very versatile. They are the specialists in the process industry when it comes to critical measuring requirements such as with highly corrosive or viscous media or when it comes to low pressures and high overload.

The scale ranges are from as low as 0 ... 16 mbar to typically 0 ... 25 to 0 ... 40 bar. Depending on the pressure range and the instrument model, overload safety of 3 x or 5 x full scale value is possible as standard.

For special designs, an overload safety of up to 400 bar is possible, with the measurement accuracy maintained.

Diaphragm pressure gauges are even suitable for highly viscous or contaminated media by using an open connecting flange (per DIN/ASME). For measuring particularly aggressive media, the complete wetted surface can be lined with a large selection of special materials (e.g. PTFE, Hastelloy, tantalum, and many more).

ERC



**422.12, 423.12**  
Grey cast iron case

Nominal size	100, 160 mm
Scale range	0 ... 16 mbar to 0 ... 40 bar
Accuracy class	1.6
Ingress protection	IP54, with liquid filling IP65
Data sheet	PM 04.02

Ex ERC Ex



**432.50, 433.50,  
432.30, 433.30,  
452.50, 453.50,  
452.30, 453.30**

For the process industry, high overload safety up to 10 times the full scale value, max. 40 bar

Nominal size	100, 160 mm
Scale range	0 ... 16 mbar to 0 ... 25 bar
Accuracy class	1.6
Ingress protection	IP54, with liquid filling IP65
Data sheet	PM 04.03

Ex ERC Ex



**432.56, 433.56,  
432.36, 433.36**

For the process industry, high overload safety to 40, 100 or 400 bar

Nominal size	100, 160 mm
Scale range	0 ... 16 mbar to 0 ... 40 bar
Accuracy class	1.6
Ingress protection	IP54, with liquid filling IP65
Data sheet	PM 04.07



# Capsule pressure gauges

## For very low pressures

These measuring instruments are particularly suited to gaseous media. The scale ranges are between 0 ... 2.5 mbar and 0 ... 1,000 mbar in accuracy classes from 0.1 to 2.5. Capsule pressure gauges consist of two circular, corrugated diaphragms, joined together around the edge with a pressure-tight seal. Overload protection is possible in certain cases.

These capsule pressure gauges are used mainly in medical, vacuum, environmental and laboratory technology for contents measurement and filter monitoring.



**611.10**  
Standard version

Nominal size	50, 63 mm
Scale range	0 ... 25 to 0 ... 600 mbar
Accuracy class	1.6
Ingress protection	IP54
Data sheet	PM 06.01



**611.13**  
Plastic case

Nominal size	50, 63 mm
Scale range	0 ... 60 to 0 ... 600 mbar
Accuracy class	2.5
Ingress protection	IP53
Data sheet	PM 06.12



**612.20**  
Stainless steel case

Nominal size	63, 100, 160 mm
Scale range	0 ... 6 to 0 ... 600 mbar
Accuracy class	1.6
Ingress protection	IP54
Data sheet	PM 06.02



**614.11, 634.11**  
Edgewise panel design

Nominal size	72 x 72, 96 x 96, 144 x 144, 144 x 72 mm
Scale range	<ul style="list-style-type: none"> <li>■ NS 72 x 72: 0 ... 25 to 0 ... 600 mbar</li> <li>■ NS 96 x 96: 0 ... 10 to 0 ... 600 mbar</li> <li>■ NS 144 x 144: 0 ... 6 to 0 ... 600 mbar</li> <li>■ NS 144 x 72: 0 ... 4 to 0 ... 600 mbar</li> </ul>
Accuracy class	1.6
Data sheet	PM 06.05



**632.50**  
For the process industry

Nominal size	63, 100, 160 mm
Scale range	<ul style="list-style-type: none"> <li>■ NS 63: 0 ... 40 to 0 ... 600 mbar</li> <li>■ NS 100: 0 ... 16 to 0 ... 600 mbar</li> <li>■ NS 160: 0 ... 2.5 to 0 ... 600 mbar</li> </ul>
Accuracy class	1.6
Ingress protection	IP54, with liquid filling IP65
Data sheet	PM 06.03



**632.51**  
For the process industry,  
high overload safety

Nominal size	100, 160 mm
Scale range	0 ... 2.5 mbar to 0 ... 100 mbar
Accuracy class	1.6
Ingress protection	IP54
Data sheet	PM 06.06



# Differential pressure gauges

Differential pressure gauges work with a wide range of pressure elements. With this variety, measuring ranges from 0 ... 0.5 mbar to 0 ... 1,000 bar and static overlay pressures up to 400 bar are possible.

These measuring instruments monitor

- the pollution degree in filter systems
- the level in closed containers
- the overpressure in clean rooms
- the flow of gaseous and liquid media
- and they control pumping plants

EAC



## 700.01, 700.02

With magnetic piston or with magnetic piston and separating diaphragm

Nominal size	80 mm
Scale range	<ul style="list-style-type: none"> <li>■ 700.01: 0 ... 400 mbar to 0 ... 10 bar</li> <li>■ 700.02: 0 ... 160 mbar to 0 ... 2.5 bar</li> </ul>
Accuracy class	<ul style="list-style-type: none"> <li>■ 700.01: ±3 %</li> <li>■ 700.02: ±5 %</li> </ul> with increasing differential pressure
Ingress protection	IP54
Data sheet	PM 07.14

EAC



## 711.12, 731.12

With parallel entry, copper alloy or stainless steel

Nominal size	100, 160 mm
Scale range	0 ... 0.6 to 0 ... 1,000 bar
Accuracy class	1.6
Ingress protection	IP33
Data sheet	PM 07.02

EAC Ex



## DPG40

With integrated working pressure indication (DELTA-plus)

Nominal size	100 mm
Scale range	0 ... 0.16 to 0 ... 10 bar
Accuracy class	2.5
Ingress protection	IP65
Data sheet	PM 07.20

EAC



## 716.11, 736.11

For very low differential pressures from 2.5 mbar, copper alloy or stainless steel

Nominal size	100, 160 mm
Scale range	<ul style="list-style-type: none"> <li>■ NS 100: 0 ... 10 to 0 ... 250 mbar</li> <li>■ NS 160: 0 ... 2.5 to 0 ... 250 mbar</li> </ul>
Accuracy class	1.6
Ingress protection	IP66
Data sheet	PM 07.07

EAC Ex



## 732.51, 733.51, 732.31, 733.31

For the process industry, all-metal media chamber

Nominal size	100, 160 mm
Scale range	0 ... 16 mbar to 0 ... 40 bar
Ambient temperature	To -70 °C
Accuracy class	1.6
Ingress protection	IP54, with liquid filling IP65
Data sheet	PM 07.05

EAC Ex



## 732.14, 733.14, 762.14, 763.14

For the process industry, high overload safety to 650 bar

Nominal size	100, 160 mm
Scale range	<ul style="list-style-type: none"> <li>■ 0 ... 60 to 0 ... 250 mbar (measuring cell DN 140)</li> <li>■ 0 ... 0.25 to 0 ... 40 bar (measuring cell DN 82)</li> </ul>
Accuracy class	1.6
Ingress protection	IP54, with liquid filling IP65
Data sheet	PM 07.13

# Absolute pressure gauges

Absolute pressure gauges are used when measured pressures are independent of the natural fluctuations in atmospheric pressure.

The pressure of the measured media is determined against a reference pressure, which corresponds to the absolute pressure zero point. For this, the reference chamber is completely evacuated, so that there is a near-perfect vacuum in it.

Applications for these high-precision measuring instruments

are, for example, monitoring of vacuum pumps and vacuum packaging machines. They are also used in laboratories, in order to monitor condensation pressures or to determine the vapour pressure of liquids.



**532.52, 533.52,  
532.53, 533.53,  
532.54, 533.54**

High overload safety



Nominal size 100, 160 mm

Scale range 0 ... 25 mbar to 0 ... 25 bar abs.,  
high overload safety

Accuracy class 1.0 or 1.6 or 2.5

Ingress protection IP54, with liquid filling IP65

Data sheet PM 05.02

# Digital pressure gauges



**CPG1200**  
Digital pressure gauge

Measuring range	-1 ... 1,000 bar
Accuracy	Down to 0.25 % FS
Special feature	<ul style="list-style-type: none"> <li>■ Integrated data logger</li> <li>■ WIKA-Cal compatible</li> <li>■ Data transmission via USB or Bluetooth®</li> <li>■ Robust case, IP65</li> </ul>

Data sheet CT 10.20



**CPG1500**  
Precision digital pressure gauge

Measuring range	0 ... 10,000 bar
Accuracy	Down to 0.025 % FS
Special feature	<ul style="list-style-type: none"> <li>■ Integrated data logger</li> <li>■ WIKA-Cal compatible</li> <li>■ Data transmission via Bluetooth®</li> <li>■ Password protection possible</li> <li>■ Robust case, IP65</li> </ul>

Data sheet CT 10.51

# Pressure sensor assemblies and modules

## Customer-specific electronic pressure measurement solutions

We see ourselves not only as a provider of top quality measurement technology, but also as a highly competent partner that is able to create individually designed solutions together with you. In close cooperation with you, we are ready to develop products that are tailor-made to cater for your individual needs. Create your perfect pressure sensor solution together with us. Here, the experience from a multitude of completed projects is incorporated – thus we can refer back to numerous proven solutions and components. As required, we will adapt our systems to your individual application or develop new ones.

Talk to us – we are happy to provide you with advice!



**MPR-1**  
Pressure sensor module

Non-linearity (± % of span)	≤ 0.125 or 0.25
Measuring range	<ul style="list-style-type: none"> <li>■ 0 ... 0.4 to 0 ... 25 bar</li> <li>■ 0 ... 0.4 to 0 ... 25 bar abs.</li> </ul>
Special feature	<ul style="list-style-type: none"> <li>■ 19 mm spanner width for limited mounting space</li> <li>■ No calibration necessary, due to compensated output signal</li> </ul>
Signal	Analogue and digital
Data sheet	PE 81.64



**MTF-1**  
Pressure sensor module

Non-linearity (± % of span)	≤ 0.125 or 0.25
Measuring range	<ul style="list-style-type: none"> <li>■ 0 ... 10 to 0 ... 1,000 bar</li> <li>■ -1 ... +9 to -1 ... +24 bar</li> </ul>
Special feature	<ul style="list-style-type: none"> <li>■ Compact design</li> <li>■ Low energy consumption</li> <li>■ Additional temperature indication</li> <li>■ Dry, welded measuring cell</li> </ul>
Signal	Analogue and digital
Data sheet	PE 83.01

# Process transmitters

Process transmitters are suitable for many industrial measuring requirements in the widest variety of applications. They monitor pumps, detect the level in containers or calculate quantities for flow measurement in pipelines.

Process transmitters differentiate themselves from pressure sensors through their increased range of functionality: They feature integrated displays, offer high measurement accuracies and freely scalable measuring ranges, communicate via digital bus signals and can be delivered with a multitude of case variants. Through connection to diaphragm seals, WIKA process transmitters are also suitable for the harshest operating conditions.



**UPT-20**  
Universal process transmitter with standard connection, Ex intrinsically safe

Non-linearity (% of span)	≤ 0.1
Output signal	4 ... 20 mA, HART®
Measuring range	<ul style="list-style-type: none"> <li>■ 0 ... 0.4 to 0 ... 4,000 bar</li> <li>■ 0 ... 1.6 to 0 ... 40 bar abs.</li> <li>■ -0.2 ... +0.2 to -1 ... +40 bar</li> </ul>
Special feature	<ul style="list-style-type: none"> <li>■ Multi-functional display</li> <li>■ Freely scalable measuring range</li> <li>■ Simple menu navigation</li> <li>■ Conductive plastic case or stainless steel case</li> <li>■ Large LC display, rotatable</li> </ul>
Data sheet	PE 86.05



**UPT-21**  
Universal process transmitter with flush process connection, Ex intrinsically safe

Non-linearity (% of span)	≤ 0.1
Output signal	4 ... 20 mA, HART®
Measuring range	<ul style="list-style-type: none"> <li>■ 0 ... 0.4 to 0 ... 600 bar</li> <li>■ 0 ... 1.6 to 0 ... 40 bar abs.</li> <li>■ -0.2 ... +0.2 to -1 ... +40 bar</li> </ul>
Special feature	<ul style="list-style-type: none"> <li>■ Hygienic process connections in different designs</li> <li>■ Electropolished stainless steel case for hygienic applications</li> <li>■ Freely scalable measuring range</li> <li>■ Conductive plastic case or stainless steel case</li> <li>■ Large LC display, rotatable</li> </ul>
Data sheet	PE 86.05



**DPT-EL**  
Electronic differential pressure transmitter in primary and secondary circuits

Non-linearity (% of span)	≤ 0.05 ... 0.1
Output signal	4 ... 20 mA, HART® protocol (optional), PROFIBUS® PA, FOUNDATION™ Fieldbus
Measuring range	<ul style="list-style-type: none"> <li>■ 0 ... 0.1 to 0 ... 1,000 bar</li> <li>■ 0 ... 1.6 to 0 ... 40 bar abs.</li> <li>■ -0.05 ... +0.05 to -1 ... +40 bar</li> </ul>
Special feature	<ul style="list-style-type: none"> <li>■ Simple, uncomplicated installation</li> <li>■ Mounting possible without diaphragm seal</li> <li>■ Elimination of capillaries, that can easily kink</li> <li>■ For applications to SIL 2 (SIL 3)</li> <li>■ Can be combined with two different designs of transmitters from model IPT-2x and/or model CPT-2x</li> </ul>
Data sheet	PE 86.23



### IPT-20, IPT-21

Process pressure transmitter with welded metal measuring cell

Non-linearity (% of span)	≤ 0.075 ... 0.1
Output signal	4 ... 20 mA, HART® protocol (optional), PROFIBUS® PA, FOUNDATION™ Fieldbus
Measuring range	<ul style="list-style-type: none"> <li>■ 0 ... 0.1 to 0 ... 4,000 bar</li> <li>■ 0 ... 0.1 to 0 ... 40 bar abs.</li> <li>■ -1 ... 0 to -1 ... +40 bar</li> </ul>
Special feature	<ul style="list-style-type: none"> <li>■ Freely scalable measuring ranges</li> <li>■ Case from plastic, aluminium or stainless steel</li> <li>■ Flush process connection (optional)</li> <li>■ With integrated display and instrument mounting bracket for wall/pipe mounting (optional)</li> <li>■ Process temperature ranges to 200 °C</li> </ul>
Data sheet	PE 86.06

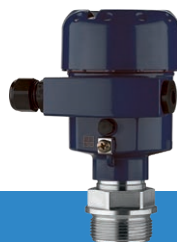

### CPT-20, CPT-21

Process pressure transmitter with capacitive ceramic measuring cell

Non-linearity (% of span)	≤ 0.05
Output signal	4 ... 20 mA, HART® protocol (optional), PROFIBUS® PA, FOUNDATION™ Fieldbus
Measuring range	<ul style="list-style-type: none"> <li>■ 0 ... 0.025 to 0 ... 100 bar abs.</li> <li>■ -1 ... 0 to -1 ... +100 bar</li> </ul>
Special feature	<ul style="list-style-type: none"> <li>■ Particularly robust, ceramic measuring cell</li> <li>■ Dry ceramic measuring cell with variable sealing concept</li> <li>■ Freely scalable measuring ranges</li> <li>■ Case from plastic, aluminium or stainless steel</li> <li>■ Flush process connection (optional)</li> </ul>
Data sheet	PE 86.07



### DPT-20

Differential pressure transmitter, intrinsically safe or with flame-proof enclosure

Non-linearity (% of span)	≤ 0.065 ... 0.1
Output signal	4 ... 20 mA, HART® protocol (optional), PROFIBUS® PA, FOUNDATION™ Fieldbus
Measuring range	0 ... 10 mbar to 0 ... 16 bar
Special feature	<ul style="list-style-type: none"> <li>■ Freely scalable measuring ranges</li> <li>■ Static load 160 bar, optionally 400 bar</li> <li>■ Case from plastic, aluminium or stainless steel</li> <li>■ With integrated display and instrument mounting bracket for wall/pipe mounting (optional)</li> <li>■ 3- or 5-way valve optional</li> <li>■ SIL 2 per IEC 61508</li> </ul>
Data sheet	PE 86.22

## Pressure measuring instruments with self-monitoring pressure indication



### DMS-FP

Diaphragm monitoring system with clamp connection

Non-linearity (% of span)	≤ 0.1 %
Output signal	<ul style="list-style-type: none"> <li>■ 4 ... 20 mA</li> <li>■ 4 ... 20 mA with a superimposed HART® communication signal (option: SIL qualification)</li> <li>■ HART® specification: 7.3 FOUNDATION™ Fieldbus PROFIBUS® PA</li> </ul>
Measuring range	< 40 bar
Special feature	<ul style="list-style-type: none"> <li>■ Double-diaphragm system to ensure the separation of the process and the pressure measuring instrument</li> <li>■ Clamp connection easy to open for cleaning and seal replacement</li> <li>■ Suitable for SIP and CIP</li> </ul>
Data sheet	DS 95.20



### DMSU21SA

Diaphragm monitoring system with HART® protocol

Non-linearity (% of span)	<ul style="list-style-type: none"> <li>■ 0.1 %</li> <li>■ 0.5 %</li> </ul>
Output signal	<ul style="list-style-type: none"> <li>■ 4 ... 20 mA with HART® signal (HART® rev. 7)</li> <li>■ 4 ... 20 mA</li> </ul>
Measuring range	<ul style="list-style-type: none"> <li>■ -1 ... +1.5 to -1 ... +24 bar</li> <li>■ -14.5 ... 20 to -14.5 ... +350 psi</li> </ul>
Special feature	<ul style="list-style-type: none"> <li>■ Double-diaphragm system prevents contamination of process and environment</li> <li>■ Hygienic process connections in different designs</li> <li>■ Signal transmission and configuration with only one cable per measuring location</li> <li>■ Minimum installation costs, even with retrofitting</li> </ul>
Data sheet	DS 95.11



### DMSU22SA

In-line process transmitter

Non-linearity (% of span)	1 % (at process temperature)
Output signal	<ul style="list-style-type: none"> <li>■ 4 ... 20 mA with HART® signal (HART® rev. 7)</li> <li>■ 4 ... 20 mA</li> </ul>
Measuring range	<ul style="list-style-type: none"> <li>■ 1 ... +15 bar</li> <li>■ 0 ... 16 bar abs.</li> <li>■ 14.5 ... +200 psi</li> </ul>
Special feature	<ul style="list-style-type: none"> <li>■ Dead-space free hygienic design with thick-walled sensor tube from stainless steel</li> <li>■ In-line pressure measurement with sensor tube without system fill fluid</li> <li>■ Continuous sensor monitoring of the double-tube system prevents contamination of process and environment</li> <li>■ Suitable for SIP and CIP</li> <li>■ EHEDG-certified and 3-A marked</li> </ul>
Data sheet	DS 95.03

# Pressure sensors



**A-10**  
For general industrial applications

Non-linearity (± % of span)	≤ 0.25 or 0.5 BFSL
Measuring range	<ul style="list-style-type: none"> <li>■ 0 ... 0.05 to 0 ... 1,000 bar</li> <li>■ 0 ... 0.1 to 0 ... 25 bar abs.</li> <li>■ -0.05 ... 0 to -1 ... +24 bar</li> </ul>
Special feature	<ul style="list-style-type: none"> <li>■ Excellent quality</li> <li>■ Exceptionally large variety</li> <li>■ Availability at short notice</li> <li>■ Particularly cost-efficient</li> </ul>
Data sheet	PE 81.60



**S-20**  
For demanding industrial applications

Non-linearity (± % of span)	≤ 0.125, 0.25 or 0.5 BFSL
Measuring range	<ul style="list-style-type: none"> <li>■ 0 ... 0.4 to 0 ... 1,600 bar</li> <li>■ 0 ... 0.4 to 0 ... 40 bar abs.</li> <li>■ -0.4 ... 0 to -1 ... +59 bar</li> </ul>
Special feature	<ul style="list-style-type: none"> <li>■ Extreme variety</li> <li>■ High accuracy</li> <li>■ Proven technology</li> <li>■ Special versions available</li> </ul>
Data sheet	PE 81.61



**S-11**  
Flush diaphragm

Non-linearity (± % of span)	≤ 0.2 BFSL
Measuring range	<ul style="list-style-type: none"> <li>■ 0 ... 0.1 to 0 ... 600 bar</li> <li>■ 0 ... 0.25 to 0 ... 16 bar abs.</li> <li>■ -0.1 ... 0 to -1 ... +24 bar</li> </ul>
Special feature	<ul style="list-style-type: none"> <li>■ Flush process connection</li> <li>■ Medium temperature to 150 °C</li> <li>■ Comprehensive stocks</li> </ul>
Data sheet	PE 81.02



**IS-3**  
Intrinsic safety Ex ia

Non-linearity (± % of span)	≤ 0.2 BFSL
Measuring range	<ul style="list-style-type: none"> <li>■ 0 ... 0.1 to 0 ... 6,000 bar</li> <li>■ 0 ... 0.25 to 0 ... 25 bar abs.</li> <li>■ -1 ... 0 to -1 ... +24 bar</li> </ul>
Special feature	<ul style="list-style-type: none"> <li>■ Ignition protection type Ex ia</li> <li>■ Large selection of approvals</li> <li>■ Exceptionally large variety</li> <li>■ Excellent quality, proven in the field</li> </ul>
Data sheet	PE 81.58



**E-10, E-11**  
Flameproof enclosure Ex d

Non-linearity (± % of span)	≤ 0.2 BFSL
Measuring range	<ul style="list-style-type: none"> <li>■ 0 ... 0.4 to 0 ... 1,000 bar</li> <li>■ 0 ... 0.4 to 0 ... 16 bar abs.</li> <li>■ -1 ... 0 to -1 ... +25 bar</li> </ul>
Special feature	<ul style="list-style-type: none"> <li>■ Low-power version</li> <li>■ For sour gas applications (NACE)</li> <li>■ Flush process connection (optional)</li> <li>■ Further worldwide Ex approvals</li> </ul>
Data sheet	PE 81.27



**A-1200**  
With IO-Link, PNP or NPN switching output

Accuracy (± % of span)	≤ 0.5 or ≤ 1
Measuring range	<ul style="list-style-type: none"> <li>■ 0 ... 0.4 to 0 ... 1,000 bar</li> <li>■ 0 ... 0.4 to 0 ... 25 bar abs.</li> <li>■ 1 ... 0 to -1 ... +24 bar</li> </ul>
Special feature	<ul style="list-style-type: none"> <li>■ IO-Link version 1.1</li> <li>■ Medium temperature to +125 °C</li> <li>■ Multicolour 360° LED status display</li> </ul>
Data sheet	PE 81.90





### HP-2

For highest-pressure applications to 15,000 bar

Accuracy (± % of span) ≤ 0.25 or 0.5

Measuring range 0 ... 1,600 to 0 ... 15,000 bar

- Special feature
- Very high long-term stability
  - Excellent load cycle stability
  - Cavitation protection (optional)

Data sheet PE 81.53



### M-10, M-11

Spanner width 19 mm



Non-linearity (± % of span) ≤ 0.2 BFSL

Measuring range 0 ... 10 to 0 ... 1,000 bar

- Special feature
- Small spanner width 19 mm
  - Flush connection G 1/4 available

Data sheet PE 81.25



### P-30, P-31

For precision measurements



Non-linearity (± % of span) ≤ 0.04 BFSL

Measuring range

- 0 ... 0.25 to 0 ... 1,000 bar
- 0 ... 0.25 to 0 ... 25 bar abs.
- -1 ... 0 to -1 ... +15 bar

- Special feature
- No additional temperature error in the range 10 ... 60 °C
  - Flush process connection (optional)
  - Analogue, CANopen® or USB

Data sheet PE 81.54

# OEM pressure sensors



## O-10

For industrial applications



Non-linearity  
(± % of span) ≤ 0.5 BFSL

Measuring range

- 0 ... 6 to 0 ... 600 bar
- -1 ... +5 to -1 ... +59 bar

Special feature

- Customer-specific solutions
- Excellent long-term stability
- Consistent quality
- Good delivery performance

Data sheet PE 81.65

## MH-4

For mobile working machines



Non-linearity  
(per IEC 62828-1) ≤ ±0.25 % of span (BFSL)

Measuring range 0 ... 6 to 0 ... 1,000 bar

Special feature

- For extreme operating conditions
- Reliable and accurate
- Customer-specific solutions
- High production capacities

Data sheet PE 81.63

## MH-4-CAN

For mobile working machines,  
CANopen®/J1939



Non-linearity  
(per IEC 62828-1) ≤ ±0.25 % of span (BFSL)

Measuring range 0 ... 40 to 0 ... 600 bar

Special feature

- For extreme operating conditions
- Signal stability thanks to CANopen®
- Reliable and accurate
- Customer-specific solutions
- High production capacities

Data sheet PE 83.02

## MH-3-HY

For mobile hydrogen applications



Accuracy  
(± % of span) ≤ 1

Measuring range 0 ... 20 to 0 ... 600 bar

Special feature

- Approval per EC79/2009
- Compact and robust design
- Diagnostic function (optional)

Data sheet PE 81.59

## MG-1

For medical gases



Non-linearity  
(± % of span) ≤ 0.5 BFSL

Measuring range 0 ... 6 to 0 ... 400 bar

Special feature Cleaned, packed and marked for oxygen per international standards

Data sheet PE 81.44



## R-1

For heating and refrigeration  
technology



Accuracy  
(± % of span) ≤ 2

Measuring range

- 0 ... 6 to 0 ... 160 bar
- -1 ... +7 to -1 ... +45 bar

Special feature

- Special case design for the best possible condensation tightness
- Resistant to all common refrigerants
- Wetted parts from stainless steel

Data sheet PE 81.45

# Pressure gauges with output signal

The multi-functional intelliGAUGEs present a cost-effective and, at the same time, reliable solution for nearly all pressure measurement applications. They combine the analogue indication of a mechanical pressure gauge, needing no auxiliary power, with the electrical output signal of a pressure sensor. These hybrid instruments are available with all commonly used electrical signals. The sensor works in a non-contact way, without any influence on the measuring signal. Many instruments are available in versions for use in hazardous areas.

Depending on the pressure gauge, the following electrical output signals are possible:

- 0.5 ... 4.5 V ratiometric
- 4 ... 20 mA, 2-wire
- 4 ... 20 mA, 2-wire with Ex approvals
- 0 ... 20 mA, 3-wire
- 0 ... 10 V, 3-wire

For pressure gauges with nominal sizes 100 and 160 mm, the electrical output signals can also be combined with switch contacts.

Ex



## PGT21

Bourdon tube,  
stainless steel case

Nominal size	50, 63 mm
Scale range	0 ... 1.6 to 0 ... 400 bar
Accuracy class	2.5
Ingress protection	IP65 (IP67 optional)
Data sheet	PV 11.03

Ex EAC IEC Ex S



## PGT23.063

Bourdon tube, for the process  
industry, safety version

Nominal size	63 mm
Scale range	0 ... 1 to 0 ... 1,000 bar
Accuracy class	1.6
Ingress protection	IP54, filled IP65
Data sheet	PV 12.03

Ex EAC IEC Ex S



## PGT23.100, PGT23.160

Bourdon tube, for the process industry,  
standard or safety version

Nominal size	100, 160 mm
Scale range	0 ... 0.6 to 0 ... 1,600 bar
Accuracy class	1.0
Ingress protection	IP54, filled IP65
Data sheet	PV 12.04

Ex EAC Ex IEC Ex Ex ATEX



## PGT43

Diaphragm element, for the  
process industry, high overload  
safety up to 10 times the full scale  
value, max. 40 bar

Nominal size	100, 160 mm
Scale range	0 ... 16 mbar to 0 ... 25 bar
Accuracy class	1.6
Ingress protection	IP54, with liquid filling IP65
Data sheet	PV 14.03

Ex EAC Ex IEC Ex Ex ATEX



## PGT43HP

Diaphragm element, for the  
process industry, high overload  
safety to 40, 100 or 400 bar

Nominal size	100, 160 mm
Scale range	0 ... 16 mbar to 0 ... 40 bar
Accuracy class	1.6
Ingress protection	IP54, with liquid filling IP65
Data sheet	PV 14.07

Ex EAC Ex IEC Ex Ex ATEX



## PGT63HP

Capsule element, for  
the process industry, high overload  
safety

Nominal size	100, 160 mm
Scale range	2.5 ... 100 mbar
Accuracy class	1.6
Ingress protection	IP54
Data sheet	PV 16.06

# Pressure gauges with output signal

## intelliGAUGE®



### DPGT43

Differential pressure,  
for the process industry,  
all-metal media chamber

Nominal size	100, 160 mm
Scale range	0 ... 16 mbar to 0 ... 40 bar
Accuracy class	1.6
Ingress protection	IP54, filled IP65
Data sheet	PV 17.05



### DPGT43HP

Differential pressure,  
for the process industry,  
high overload safety to 650 bar

Nominal size	100, 160 mm
Scale range	0 ... 60 mbar to 0 ... 40 bar
Accuracy class	1.6
Ingress protection	IP54, filled IP65
Data sheet	PV 17.13



### DPGT40

Differential pressure, with integrated  
working pressure indication (DELTA-  
trans)

Nominal size	100 mm
Scale range	0 ... 160 mbar to 0 ... 10 bar
Accuracy class	2.5 (1.6 optional)
Ingress protection	IP65
Data sheet	PV 17.19



### APGT43

Absolute pressure,  
for the process industry

Nominal size	100, 160 mm
Scale range	0 ... 25 mbar to 0 ... 25 bar abs.
Accuracy class	2.5
Ingress protection	IP54, with liquid filling IP65
Data sheet	PV 15.02

# Contact pressure gauges

Control systems are gaining more and more importance in industrial applications. Consequently, mere pressure indication on the measuring instrument itself is no longer sufficient, rather the measured value must be transferred to the control system via an electrical signal, e.g. by closing or opening of a circuit. WIKA is focusing on its contact pressure gauges in order to satisfy this trend.

All instruments with inductive contacts are certified in accordance with ATEX Ex ia.

Depending on the model the following contacts are built-in:

- Magnetic snap-action contact, e.g. model 821, for general applications
- Inductive contact model 831, for hazardous areas
- Electronic contact model 830 E, for PLC
- Reed contact model 851, for general applications and PLC
- Microswitch model 850
- Transistor output NPN or PNP



Ex VdS

## PGS21

Bourdon tube,  
stainless steel case

Nominal size	40, 50, 63 mm
Scale range	0 ... 2.5 to 0 ... 400 bar
Accuracy class	2.5
Ingress protection	IP65
Special feature	Version with VdS or LPCB approval possible
Data sheet	PV 21.02



Ex

## PGS25

Bourdon tube, with  
electronic pressure switch,  
stainless steel case

Nominal size	50, 63 mm
Scale range	0 ... 1.6 to 0 ... 400 bar
Accuracy class	2.5
Ingress protection	IP65
Data sheet	PV 21.04



Ex EAC IEC 60079

## PGS21.100, PGS21.160

Bourdon tube, stainless steel case

Nominal size	100, 160 mm
Scale range	0 ... 0.6 to 0 ... 600 bar
Accuracy class	1.0
Ingress protection	IP54
Data sheet	PV 22.01



Ex EAC IEC 60079 S

## PGS23.100, PGS23.160

Bourdon tube, for the process industry,  
standard or safety version

Nominal size	100, 160 mm
Scale range	0 ... 0.6 to 0 ... 1,600 bar
Accuracy class	1.0
Ingress protection	IP65 or IP66
Data sheet	PV 22.02

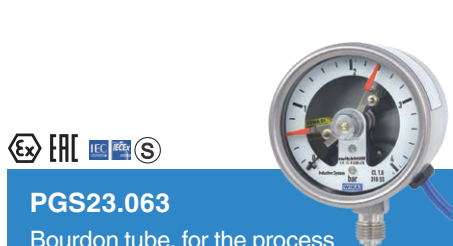

Ex EAC IEC 60079 S

## PGS23.063

Bourdon tube, for the process  
industry, safety version

Nominal size	63 mm
Scale range	0 ... 4 to 0 ... 400 bar
Accuracy class	1.6
Ingress protection	IP54
Data sheet	PV 22.03



Ex EAC IEC 60079 ATEX S

## PGS43.100, PGS43.160

Diaphragm element, for the process industry,  
high overload safety up to 10 times the  
full scale value, max. 40 bar

Nominal size	100, 160 mm
Scale range	0 ... 25 mbar to 0 ... 25 bar
Accuracy class	1.6
Ingress protection	IP54, with liquid filling IP65
Data sheet	PV 24.03

# Contact pressure gauges



**432.36,  
432.56 with 8xx**

Diaphragm element, for the process industry, high overload safety to 100 or 400 bar

Nominal size	100, 160 mm
Scale range	0 ... 25 mbar to 0 ... 40 bar
Accuracy class	1.6
Ingress protection	IP54, with liquid filling IP65
Data sheet	PV 24.07



**532.53 with 8xx**

Absolute pressure, for the process industry, high overload safety

Nominal size	100, 160 mm
Scale range	0 ... 25 mbar to 0 ... 25 bar abs.
Accuracy class	1.6
Ingress protection	IP54, with liquid filling IP65
Data sheet	PV 25.02



**632.51 with 8xx**

Capsule element, for the process industry, high overload safety

Nominal size	100, 160 mm
Scale range	0 ... 2.5 to 0 ... 100 mbar
Accuracy class	1.6
Ingress protection	IP54
Data sheet	PV 26.06



**DPGS40**

Differential pressure, with microswitches, with integrated working pressure indication (DELTA-comb)

Nominal size	100 mm
Scale range	0 ... 250 mbar to 0 ... 10 bar
Accuracy class	2.5 (1.6 optional)
Ingress protection	IP65
Data sheet	PV 27.20



**DPGS40TA**

Differential pressure, with microswitches, with integrated working pressure indication (DELTA-comb), with component testing

Nominal size	100 mm
Scale range	0 ... 250 mbar to 0 ... 10 bar
Accuracy class	2.5 (1.6 optional)
Ingress protection	IP65
Data sheet	PV 27.22



**DPGS43**

Differential pressure, for the process industry, all-metal media chamber

Nominal size	100, 160 mm
Scale range	0 ... 16 mbar to 0 ... 40 bar
Accuracy class	1.6
Ingress protection	IP54, filled IP65
Data sheet	PV 27.05



**DPGS43HP**

Differential pressure, for the process industry, high overload safety to 400 bar

Nominal size	100, 160 mm
Scale range	0 ... 60 mbar to 0 ... 40 bar
Accuracy class	1.6
Ingress protection	IP54, filled IP65
Data sheet	PV 27.13

# Pressure switches

## Electronic pressure switches

 IO-Link



### PSD-4

Electronic pressure switch with display

Accuracy  
(± % of span) ≤ 0.5

Measuring range

- 0 ... 0.4 to 0 ... 1,000 bar
- 0 ... 0.4 to 0 ... 25 bar abs.
- -1 ... 0 to -1 ... +24 bar

Special feature

- Condition monitoring via IO-Link
- Reduction of variants
- Easy installation, good readability
- Parameterisation via 3 buttons

Data sheet PE 81.86

 IO-Link



### PSD-4-ECO

Electronic pressure switch with display

Accuracy  
(± % of span) ≤ 1.0

Measuring range

- 0 ... 0.4 to 0 ... 1,000 bar
- 0 ... 0.4 to 0 ... 25 bar abs.
- -1 ... 0 to -1 ... +24 bar

Special feature

- Good/Bad indication through parameterisable digital display (red/green)
- Compact size enables easy installation in confined spaces
- Optimised design makes OEM machine integration easier
- Designed for rough demands to 50g shock and -40 ... +125 °C [-40 ... +257 °F]

Data sheet PE 81.69

 IO-Link



### A-1200

With IO-Link, PNP or NPN switching output

Accuracy  
(± % of span) ≤ 0.5 or ≤ 1

Measuring range

- 0 ... 0.4 to 0 ... 1,000 bar
- 0 ... 0.4 to 0 ... 25 bar abs.
- 1 ... 0 to -1 ... +24 bar

Special feature

- IO-Link version 1.1
- Medium temperature to +125 °C
- Multicolour 360° LED status display

Data sheet PE 81.90

# Pressure switches

## Mechanical pressure switches for industrial applications



### PSM01

Compact pressure switch

Setting range	-0.85 ... -0.15 bar 0.2 ... 2 bar to 30 ... 320 bar
Switching function	Normally open, normally closed, change-over contact
Material	Galvanised steel or stainless steel
Switching power	■ 2 A, AC 48 V ■ 1 A / 2 A, DC 24 V
Data sheet	PV 34.81



### PSM02

Compact pressure switch, settable hysteresis

Setting range	-0.85 ... -0.15 bar 0.2 ... 2 bar to 30 ... 320 bar
Switching function	Normally open, normally closed, change-over contact
Material	Galvanised steel or stainless steel
Switching power	■ 2 A / 4 A, AC 250 V ■ 2 A / 4 A, DC 24 V
Data sheet	PV 34.82



### PSM-520

Pressure switch, settable hysteresis

Setting range	■ -0.4 ... +7 bar ■ 0 ... 5 bar to 6 ... 30 bar
Switching function	Normally open, normally closed, change-over contact
Material	■ Bellows: Copper alloy CuSn6 per EN 1652 ■ Process connection: free cutting steel EN1A per EN 10277-3, tin-plated
Switching power	10 A / 6 A, AC 230 V
Data sheet	PV 35.01



### PSM-550

Pressure switch, for demanding industrial applications

Setting range	■ -1 ... 0 and -0.8 ... +5 bar ■ 0 ... 300 mbar ■ 0.1 ... 1.1 bar to 10 ... 30 bar
Switching function	Change-over contact (SPDT)
Material	■ Bellows / Process connection: Copper alloy CuSn6 per EN 1652 or stainless steel 1.4401 ■ With NBR diaphragm: Process connection: free cutting steel EN1A per EN 10277-3, tin-plated
Switching power	4 A / 10 A, AC 230 V
Data sheet	PV 35.03



### PSM-700

Pressure switch, high adjustability of switch differential

Setting range	■ -1 ... 1.5 bar ■ 0.2 ... 1.6 bar, 7 ... 35 bar
Switching function	Change-over contact (SPDT and DPDT)
Material	■ Measuring element: Stainless steel 316L ■ Process connection: Stainless steel 316L ■ Case: Aluminium
Switching power	Up to AC 250 V/15 A
Data sheet	PV 35.05



## Mechanical pressure switches for the process industry

Due to the use of high-quality microswitches, the mechanical pressure switches are notable for their high precision and long-term stability. Furthermore, the direct switching of electrical loads up to AC 250 V/20 A is enabled, while simultaneously ensuring a high switch point reproducibility.

The instruments come with a SIL certificate and are thus particularly suited for safety-critical applications. In addition, with their 'intrinsically safe' and 'flameproof enclosure' ignition protection types the pressure switches are ideally suited for permanent use in hazardous areas.

All mechanical pressure switches for the process industry are available with EAC certificate and technical passport.



### PXS, PXA

Miniature pressure switch

Setting range 1 ... 2.5 to 200 ... 1,000 bar

Ignition protection type Ex ia or Ex d

Switch 1 x SPDT or DPDT

Switching power ■ AC 250 V/5 A  
■ DC 24 V/5 A

Data sheet PV 34.36, PV 34.38



### PCS, PCA

Compact pressure switch

Setting range -1 ... -0.2 to 200 ... 1,000 bar

Ignition protection type Ex ia or Ex d

Switch 1 x SPDT or DPDT

Switching power ■ AC 250 V/15 A  
■ DC 24 V/2 A

Data sheet PV 33.30, PV 33.31



### MW, MA

Diaphragm pressure switch

Setting range 0 ... 16 mbar to 30 ... 600 bar

Ignition protection type Ex ia or Ex d

Switch 1 or 2 x SPDT or 1 x DPDT

Switching power ■ AC 250 V/20 A  
■ DC 24 V/2 A

Data sheet PV 31.10, PV 31.11



### BWX, BA

Bourdon tube pressure switch

Setting range 0 ... 2.5 to 0 ... 1,000 bar

Ignition protection type Ex ia or Ex d

Switch 1 or 2 x SPDT or 1 x DPDT

Switching power ■ AC 250 V/20 A  
■ DC 24 V/2 A

Data sheet PV 32.20, PV 32.22



### DW, DA

Differential pressure switch

Setting range 0 ... 16 mbar to 0 ... 40 bar,  
static pressure to 160 bar

Ignition protection type Ex ia or Ex d

Switch 1 or 2 x SPDT or 1 x DPDT

Switching power ■ AC 250 V/20 A  
■ DC 24 V/2 A

Data sheet PV 35.42, PV 35.43, PV 35.50



### APW, APA

Absolute pressure switch

Setting range 0 ... 25 mbar to 0 ... 1.5 bar abs.

Proof pressure 11 bar abs.

Ignition protection type Ex ia or Ex d

Switch 1 or 2 x SPDT or 1 x DPDT

Data sheet PV 35.49, PV 35.48

# Diaphragm seal systems

These combinations of diaphragm seals and pressure gauges or pressure sensors feature fast availability. They are particularly suitable for demanding measuring requirements in the pharmaceutical and biotechnology industries, food and beverage industries, and through to the oil and gas, chemical, petrochemical and semiconductor industries.

The diaphragm seal systems can be used for processes with gases, compressed air or vapour, with liquid, pasty, powdery and

crystallising media and also with aggressive, adhesive, corrosive, highly viscous, environmentally hazardous or toxic media.

The diaphragm seal is directly welded to the pressure gauge or pressure sensor. The diaphragm made of stainless steel provides for the separation from the medium. The pressure is transmitted to the measuring instrument via the system fill fluid which is inside the diaphragm seal system.

## With flange connection



### DSS26M

With pressure gauge per EN 837-1, internal diaphragm

Applications with small flange process connections in the process industry

PN max.	40 bar
System fill fluid	KN2 for general applications
Data sheet	DS 95.09

## With threaded connection



### DSS34M

With pressure gauge per EN 837-1, welded design

Applications with high requirements in the chemical, petrochemical and water treatment industries

PN max.	60 bar
System fill fluid	KN2 for general applications
Data sheet	DS 95.15



Extensive information can be found in our brochure “Diaphragm seals – combinations and accessories” at [www.wika.com](http://www.wika.com).



### DSS26T

With high-quality pressure sensor, internal diaphragm

Applications with small flange process connections in the process industry

PN max.	40 bar
System fill fluid	KN2 for general applications
Data sheet	DS 95.10



### DSS34T

With high-quality pressure sensor, welded design

Applications with high requirements in the chemical, petrochemical and water treatment industries

PN max.	60 bar
System fill fluid	KN2 for general applications
Data sheet	DS 95.16



Extensive information can be found in our brochure “Diaphragm seal systems with short delivery times” at [www.wika.com](http://www.wika.com).

# Valves and mounting accessories

Valves and protective devices for increased safety and service life. Via cocks, shut-off valves, valve manifolds or monoflanges, pressure measuring instruments can be securely separated from the process during commissioning, maintenance or calibration. Protective devices, such as syphons, overpressure protectors

and snubbers, increase the service life and expand the range of applications for pressure measuring instruments. In addition to the extensive selection of instrumentation valves and accessories, WIKA also offers the qualified assembly of various individual parts to form a complete measuring assembly ("instrument hook-up").



EAC

## IV10, IV11

Needle valve and multiport valve

Application	For shutting off pressure measuring instruments with threaded connection
Version	Needle valve and multiport valve
Material	Stainless steel
Nominal pressure	To PN 420 (6,000 psi) Option: to PN 680 (10,000 psi)
Data sheet	AC 09.22

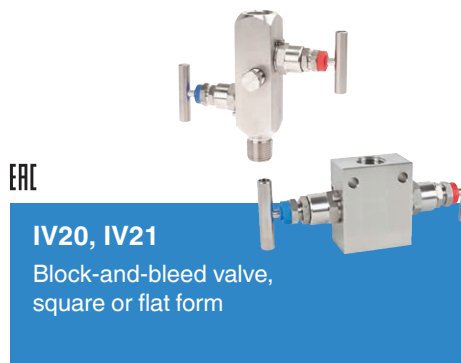

EAC

## IV20, IV21

Block-and-bleed valve, square or flat form

Application	For shutting off and venting pressure measuring instruments with threaded connection
Version	Block-and-bleed valve
Material	Stainless steel
Nominal pressure	To PN 420 (6,000 psi) Option: to PN 680 (10,000 psi)
Data sheet	AC 09.19

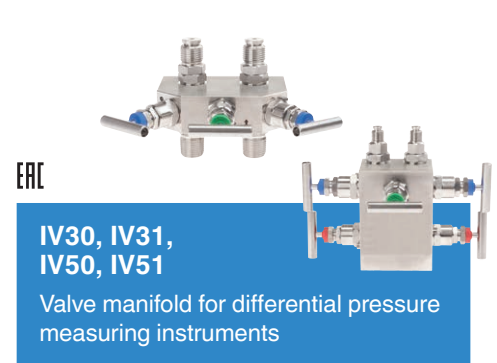

EAC

## IV30, IV31, IV50, IV51

Valve manifold for differential pressure measuring instruments

Application	For shutting off, pressure equalising as well as purging and venting differential pressure measuring instruments
Version	3-way and 5-way valve
Material	Stainless steel
Nominal pressure	To PN 420 (6,000 psi) Option: to PN 680 (10,000 psi)
Data sheet	AC 09.23

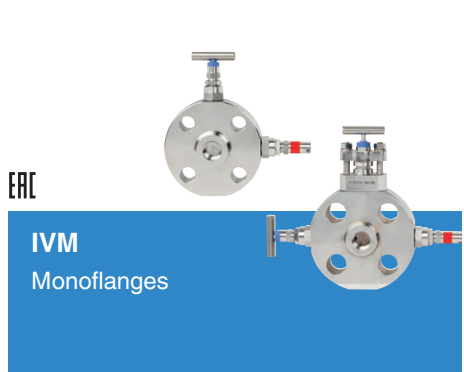

EAC

## IVM

Monoflanges

Application	For shutting off and venting pressure measuring instruments with flange connection
Version	Flange connection per ASME or EN
Material	Stainless steel
Nominal pressure	To PN 420 (6,000 psi)
Data sheet	AC 09.17

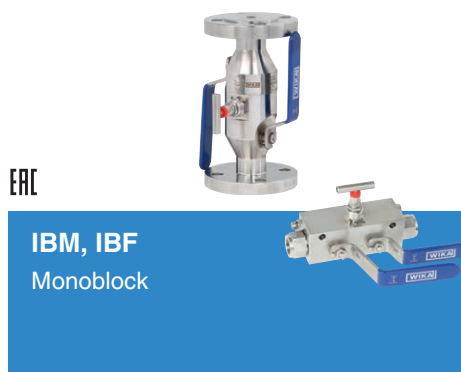

EAC

## IBM, IBF

Monoblock

Application	Direct connection of pressure measuring instruments to pipelines or containers without interface valves. Control panels, lubrication systems, dry gas seals
Version	Flange/threaded, flange/flange or threaded/threaded
Material	Stainless steel
Nominal pressure	BF: class 150 ... class 2,500, in line with ASME B16.5 PN 16 ... PN 100, in line with EN 1092-1 IBM: 6,000 ... 10,000 psi (420 ... 690 bar)
Data sheet	AC 09.24, AC 09.25



## 910.10, 910.11

Stopcock and DIN shut-off valve

Application	For shutting off pressure measuring instruments with threaded connection
Version	910.10: per DIN 16261, DIN 16262, DIN 16263 910.11: per DIN 16270, DIN 16271, DIN 16272
Material	Brass, steel, stainless steel
Nominal pressure	910.10: to 25 bar 910.11: to 400 bar
Data sheet	AC 09.01, AC 09.02

# Valves and mounting accessories

ERIC

## BV Ball valve



**Application** First shut-off valve for pressure tap to local instrument installation, media distribution, drain or vent in pipelines

<b>Version</b>	Process and instrument version
<b>Material</b>	Stainless steel 316L
<b>Nominal pressure</b>	To PN 420 (6,000 psi) Option: to PN 680 (10,000 psi)
<b>Data sheet</b>	AC 09.28

## HPNV High-pressure needle valve



**Application** For injection systems, test benches, hydraulic power packs, blow-out protection, blasting/cutting with water, high-pressure cleaning

<b>Version</b>	2-way valve, straight or angled bore; 3-way valve, one or two pressure connections
<b>Material</b>	Stainless steel
<b>Nominal pressure</b>	15,000 ... 60,000 psi [1,034 ... 4,136 bar] Option: To PN 680 (10,000 psi)
<b>Data sheet</b>	AC 09.27

## 910.12 Snubber



**Application** For the protection of pressure measuring instruments from pressure surges and pulsations

<b>Material</b>	Brass, steel, stainless steel
<b>Nominal pressure</b>	To 400 bar
<b>Data sheet</b>	AC 09.03

## 910.15 Syphons and connecting pipes



**Application** For the protection of pressure measuring instruments from excessive pulsation and heat

<b>Version</b>	U-form, trumpet form, compact form, standard
<b>Material</b>	Steel, stainless steel
<b>Nominal pressure</b>	To 160 bar
<b>Data sheet</b>	AC 09.06

## HPFA High-pressure fittings and accessories



**Application** For high-pressure applications in control panels, where the space is restricted, or test benches

<b>Version</b>	Elbow fitting, T-fitting, cross fitting, bulkhead connector, anti-vibration gland, gland collar, threaded connection, nipple, sealing cap, blind plug
<b>Material</b>	Stainless steel
<b>Nominal pressure</b>	15,000 ... 60,000 psi [1,034 ... 4,136 bar]
<b>Data sheet</b>	AC 09.32

Extensive information can be found in our brochure "Instrumentation valves and mounting accessories" at [www.wika.com](http://www.wika.com).



# Electrical accessories



## A-AI-1, A-IAI-1



LCD attachable indicator, 50 x 50 mm

Input	4 ... 20 mA, 2-wire
Auxiliary power	Supply from the 4 ... 20 mA current loop
Special feature	Model A-IAI-1 intrinsically safe per ATEX
Data sheet	AC 80.07



## M12 x 1 cable

Preassembled cables M12 x 1



- Circular connector M12 x 1, 4- and 5-pin
- Straight and angled version
- 2, 5 or 10 m cable
- Ingress protection IP67



## 905

Contact protection relay  
for model 821 switch contacts

Application	For optimal contact protection and highest switching reliability
Data sheet	AC 08.05



## 904

Control unit  
for inductive contacts model 831

Application	For operating measuring instruments with inductive switch contacts
Data sheet	AC 08.04

# Dial thermometers

Our dial thermometers work on the bimetal, expansion or gas actuation principle. This enables scale ranges of -200 ... +700 °C in different class accuracies, response times and resilience to environmental influences.

Diverse connection designs, stem diameters and individual stem lengths enable a flexible measuring point design. Dial thermometers with capillaries are particularly versatile.

All thermometers are suited for operation in a thermowell if necessary.

## Bimetal thermometers



**A43**  
Heating technology

Nominal size	63, 80, 100 mm
Scale range	-30 ... +120 °C
Permissible operating pressure at thermowell/stem	Max. 6 bar
Wetted parts	Copper alloy
Data sheet	TM 43.01



**A48**  
Refrigeration and air-conditioning applications

Nominal size	63, 80, 100, 160 mm
Scale range	-30 ... +120 °C
Wetted parts	Copper alloy
Data sheet	TM 48.01



**A50**  
Standard version

Nominal size	63, 80, 100, 160 mm
Scale range	-30 ... +200 °C
Connection	Removable thermowell with retainer screw
Wetted parts	Copper alloy
Data sheet	TM 50.03



**A52, R52**  
Industrial series, axial and radial

Nominal size	25, 33, 40, 50, 63, 80, 100, 160 mm
Scale range	-30 ... +50 to 0 ... +500 °C
Permissible operating pressure at thermowell/stem	Max. 25 bar
Wetted parts	Stainless steel
Data sheet	TM 52.01



**TG53**  
Process version per ASME B40.200

Nominal size	3, 4, 5, 6"
Scale range	-70 ... +70 to 0 ... +600 °C
Wetted parts	Stainless steel
Option	Liquid damping to max. 250 °C (case and probe)
Data sheet	TM 53.02



**TG54**  
Process version per EN 13190

Nominal size	63, 80, 100, 160 mm
Scale range	-70 ... +70 to 0 ... +600 °C
Wetted parts	Stainless steel
Option	Liquid damping to max. 250 °C (case and probe)
Data sheet	TM 54.02

## Bimetal thermometers



**55**  
High-quality process version  
per EN 13190

Nominal size	63, 100, 160 mm
Scale range	-70 ... +70 to 0 ... 600 °C
Wetted parts	Stainless steel
Option	Liquid damping to max. 250 °C (case and probe)
Data sheet	TM 55.01



**TG58SA**  
Bimetal thermometer  
for sanitary applications

Nominal size	63, 80, 100, 130 mm
Scale range	-50 ... 50 °C to -20 ... 200 °C
Wetted parts	Stainless steel 316L
Option	<ul style="list-style-type: none"> <li>Case filling with FDA-approved silicone oil</li> <li>Certification packages for food and pharmaceutical applications</li> </ul>
Data sheet	TM 58.01

## Machine glass thermometer



**32**  
V shape

Nominal size	110, 150, 200 mm
Scale range	-30 ... +200 °C
Wetted parts	Copper alloy
Option	<ul style="list-style-type: none"> <li>Dual scale °F/°C</li> <li>2 variants: straight and 90°</li> </ul>
Data sheet	TM 32.02

## Expansion thermometers



**TF58, TF59**  
With capillary, edgewise panel design

Nominal size	58 x 25 mm, 62 x 11 mm
Scale range	-50 ... 250 °C
Wetted parts	Copper alloy
Option	<ul style="list-style-type: none"> <li>Vertical arrangement</li> <li>Special scales</li> </ul>
Data sheet	TM 80.02



**70**  
With capillary,  
stainless steel version

Nominal size	63, 100, 160 mm
Scale range	-60 ... +400 °C
Wetted parts	Stainless steel
Option	<ul style="list-style-type: none"> <li>Liquid damping (case)</li> <li>Indication accuracy class 1</li> </ul>
Data sheet	TM 81.01



**IFC**  
With capillary, standard version

Nominal size	52, 60, 80, 100 mm 48 x 48, 72 x 72, 96 x 96 mm
Scale range	-100 ... +400 °C
Wetted parts	Copper alloy
Option	<ul style="list-style-type: none"> <li>Square case version</li> <li>Other case materials</li> </ul>
Data sheet	TM 80.01

# Dial thermometers

## Gas-actuated thermometers



### R73, S73, A73

Axial and radial, adjustable stem and dial

Nominal size	100, 160 mm
Scale range	-200 ... +100 to 0 ... +700 °C
Wetted parts	Stainless steel
Option	<ul style="list-style-type: none"> <li>■ Liquid damping (case)</li> <li>■ Contact bulb</li> </ul>
Data sheet	TM 73.01



### F73

With capillary

Nominal size	100, 160 mm
Scale range	-200 ... +100 to 0 ... +700 °C
Wetted parts	Stainless steel
Option	<ul style="list-style-type: none"> <li>■ Armoured or coated capillary (PVC coating)</li> <li>■ Liquid damping (case)</li> <li>■ Contact bulb</li> </ul>
Data sheet	TM 73.01



### 75

Highly vibration-resistant

Nominal size	100 mm
Scale range	0 ... +700 or -50 ... +650 °C
Wetted parts	Stainless steel
Option	Various neck tube and insertion lengths
Data sheet	TM 75.01

## Thermomanometers



### MFT

With capillaries, for pressure and temperature measurement

Nominal size	40, 42, 52 mm
Scale range	<ul style="list-style-type: none"> <li>■ Pressure: 0 ... 4 bar</li> <li>■ Temperature: 0 ... 120 °C</li> </ul>
Accuracy class	<ul style="list-style-type: none"> <li>■ Pressure: 2.5 (EN 837-1)</li> <li>■ Temperature: 2.5</li> </ul>
Data sheet	PM 01.20



### THM10

Eco version, for pressure and temperature measurement

Nominal size	63, 80 mm
Scale range	<ul style="list-style-type: none"> <li>■ Pressure: 0 ... 4 to 0 ... 10 bar</li> <li>■ Temperature: 0 ... 120 °C</li> </ul>
Connection location	Lower mount or back mount
Accuracy class	<ul style="list-style-type: none"> <li>■ Pressure: 2.5 (EN 837-1)</li> <li>■ Temperature: 2 (EN 13190)</li> </ul>
Data sheet	PM 01.24



### 100.02

For pressure and temperature measurement

Nominal size	63, 80 mm
Scale range	<ul style="list-style-type: none"> <li>■ Pressure: 0 ... 1 to 0 ... 16 bar</li> <li>■ Temperature: 0 ... 100 to 0 ... 150 °C</li> </ul>
Accuracy class	<ul style="list-style-type: none"> <li>■ Pressure: 2.5 (EN 837-1)</li> <li>■ Temperature: 2.5 °C</li> </ul>
Data sheet	PM 01.23



## Dial thermometers with output signal



ERC

**TGT70**Expansion thermometer  
with output signal

Nominal size	63, 100 mm
Scale range	-40 ... +60 to 0 ... 250 °C
Wetted parts	Stainless steel

Option	<ul style="list-style-type: none"> <li>■ Capillary</li> <li>■ Output signals 4 ... 20 mA or 0.5 ... 4.5 V</li> <li>■ Other connection designs</li> </ul>
--------	--

Data sheet TV 18.01



ERC IEC ATEX

**TGT73**Gas-actuated thermometer  
with output signal

Nominal size	100, 160 mm
Scale range	-200 ... +100 to 0 ... 700 °C
Wetted parts	Stainless steel

Option	<ul style="list-style-type: none"> <li>■ Capillary</li> <li>■ Liquid damping (case)</li> <li>■ Output signal 4 ... 20 mA or 0 ... 10 V</li> </ul>
--------	---

Data sheet TV 17.10

# Digital indicators



## DI10

For panel mounting, current loop display, 96 x 48 mm

Input	4 ... 20 mA, 2-wire
Alarm output	2 electronic contacts (optional)
Special feature	Wall-mounting case (optional)
Auxiliary power	Supply from the 4 ... 20 mA current loop
Data sheet	AC 80.06



## DI30

For panel mounting, 96 x 96 mm

Input	Standard signals
Alarm output	2 relays
Special feature	<ul style="list-style-type: none"> <li>■ Integrated transmitter power supply</li> <li>■ Wall-mounting case (optional)</li> </ul>
Auxiliary power	AC 230 V or AC 115 V
Data sheet	AC 80.05



## DI32-1

For panel mounting, 48 x 24 mm

Input	Multi-function input for resistance thermometers, thermocouples and standard signals
Alarm output	2 electronic contacts
Auxiliary power	DC 9 ... 28 V
Data sheet	AC 80.13



## DI35

For panel mounting, 96 x 48 mm

Input	<ul style="list-style-type: none"> <li>■ Multi-function input for resistance thermometers, thermocouples and standard signals</li> <li>■ Alternatively double input for standard signals with calculation function (+ - x /) for two transmitters</li> </ul>
Alarm output	2 or 4 relays (optional)
Special feature	<ul style="list-style-type: none"> <li>■ Integrated transmitter power supply</li> <li>■ Analogue output signal (optional)</li> </ul>
Auxiliary power	<ul style="list-style-type: none"> <li>■ AC/DC 100 ... 240 V</li> <li>■ DC 10 ... 40 V, AC 18 ... 30 V</li> </ul>
Data sheet	AC 80.03



### DIH10

Connection head with digital indicator

Input	4 ... 20 mA
Auxiliary power	Supply from the 4 ... 20 mA current loop
Data sheet	AC 80.11



### DIH50, DIH52

For current loops with HART® communication

Dimensions	150 x 127 x 127 mm
Case	Aluminium, stainless steel
Special feature	<ul style="list-style-type: none"> <li>■ Adjustment of display range and unit via HART® communication</li> <li>■ Model DIH52 additionally suitable for multidrop operation and with local master function</li> </ul>
Approval	<ul style="list-style-type: none"> <li>■ Intrinsically safe</li> <li>■ Flameproof enclosure</li> </ul>
Data sheet	AC 80.10



### TF-LCD

Temperature probe for heating and refrigeration technology, with digital indicator

Measuring range	-40 ... +120 °C
Special feature	<ul style="list-style-type: none"> <li>■ Dust and waterproof case, IP68</li> <li>■ Battery or solar operation</li> <li>■ Extremely long service life</li> </ul>
Data sheet	TE 85.01

# Thermocouples

Thermocouples generate a voltage directly dependent on temperature. They are particularly suitable for high temperatures to 1,700 °C (3,092 °F) and for very high oscillating stresses. For thermocouples, the accuracy classes per IEC 60584-1 and ASTM E230 apply.

In our range of products you will find all market-standard instrument versions. If required, a temperature transmitter can be installed in the connection head.



**TC10-A**  
Measuring insert

Sensor element Types K, J, E, N or T  
 Measuring range -40 ... +1,200 °C, -40 ... +2,192 °F  
 Measuring location Ungrounded or grounded  
 Data sheet TE 65.01



**TC10-B**  
For additional thermowell

Sensor element Types K, J, E, N or T  
 Measuring range -40 ... +1,200 °C, -40 ... +2,192 °F  
 Measuring location Ungrounded or grounded  
 Data sheet TE 65.02



**TC10-C**  
Threaded, with protection tube

Sensor element Types K, J, E, N or T  
 Measuring range -40 ... +1,200 °C, -40 ... +2,192 °F  
 Measuring location Ungrounded or grounded  
 Process connection Mounting thread  
 Data sheet TE 65.03



**TC10-D**  
Threaded, miniature design

Sensor element Types K, J, E, N or T  
 Measuring range -40 ... +600 °C, -40 ... +1,112 °F  
 Measuring location Ungrounded or grounded  
 Process connection Mounting thread  
 Data sheet TE 65.04



**TC10-F**  
Flanged thermocouple, with protection tube

Sensor element Types K, J, E, N or T  
 Measuring range -40 ... +1,200 °C, -40 ... +2,192 °F  
 Measuring location Ungrounded or grounded  
 Process connection Flange  
 Data sheet TE 65.06



**TC10-H**  
Without thermowell

Sensor element Types K, J, E, N or T  
 Measuring range -40 ... +1,200 °C, -40 ... +2,192 °F  
 Measuring location Ungrounded or grounded  
 Process connection Mounting thread  
 Data sheet TE 65.08



**TC10-K**  
Measuring insert,  
for installation in TC10-L

Sensor element	Types K, J, E, N or T
Measuring range	-40 ... +1,200 °C, -40 ... +2,192 °F
Measuring location	Ungrounded or grounded
Data sheet	TE 65.11



**TC10-L**  
Flameproof enclosure,  
for additional thermowell

Sensor element	Types K, J, E, N or T
Measuring range	-40 ... +1,200 °C, -40 ... +2,192 °F
Measuring location	Ungrounded or grounded
Data sheet	TE 65.12



**TC12-A**  
Measuring insert for  
process thermocouple

Sensor element	Types K, J, N or T
Measuring range	-40 ... +1,200 °C, -40 ... +2,192 °F
Measuring location	Ungrounded or grounded
Data sheet	TE 65.16



**TC12-B**  
Process thermocouple,  
for additional thermowell

Sensor element	Types K, J, E, N or T
Measuring range	-40 ... +1,200 °C, -40 ... +2,192 °F
Measuring location	Ungrounded or grounded
Option	Ex i, Ex d
Data sheet	TE 65.17



**TC12-M**  
Process thermocouple,  
basic module

Sensor element	Types K, J, E, N or T
Measuring range	-40 ... +1,200 °C, -40 ... +2,192 °F
Measuring location	Ungrounded or grounded
Option	Ex i, Ex d
Data sheet	TE 65.17

# Thermocouples

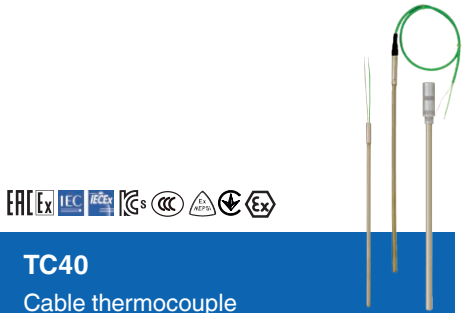

## TC40 Cable thermocouple

Sensor element	Types K, J, E, N or T
Measuring range	-40 ... +1,200 °C, -40 ... +2,192 °F
Measuring location	Ungrounded or grounded
Cable	Silicone, PTFE/PFA, fibreglass
Data sheet	TE 65.40

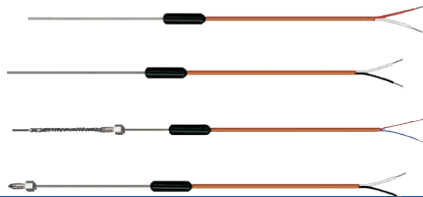

## TC46 Hot runner thermocouple

Sensor element	Types J or K
Measuring range	-25 ... +400 °C, -13 ... +752 °F
Measuring location	Ungrounded or grounded
Special feature	<ul style="list-style-type: none"> <li>■ Probe diameter 0.5 ... 3.0 mm</li> <li>■ Plastic-moulded transition</li> </ul>
Data sheet	TE 65.46



## TC47 Thermocouple for plastics machinery

Sensor element	Types J or K
Measuring range	-25 ... +400 °C, -13 ... +752 °F
Measuring location	Ungrounded or grounded
Special feature	<ul style="list-style-type: none"> <li>■ Various process connections</li> <li>■ Connection lead fibreglass with stainless steel braid</li> </ul>
Data sheet	TE 67.20



## TC50 Surface thermocouple

Sensor element	Types K, J, E, N or T
Measuring range	-40 ... +1,200 °C, -40 ... +2,192 °F
Measuring location	Ungrounded or grounded
Process connection	Surface mounting
Data sheet	TE 65.50

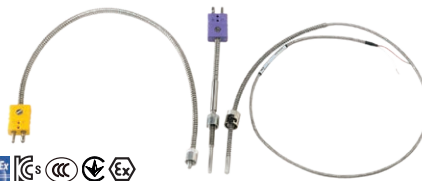

## TC53 Bayonet thermocouple

Sensor element	Types K, J, N, E or T
Measuring range	-40 ... +1,200 °C, -40 ... +2,192 °F
Measuring location	Ungrounded or grounded
Special feature	<ul style="list-style-type: none"> <li>■ Single and dual thermocouple</li> <li>■ Explosion-protected versions</li> </ul>
Data sheet	TE 65.53



**TC59-T**  
TEFRACTO-PAD®  
Tubeskin thermocouple assembly

Sensor element	Types K, J, N, E
Measuring range	0 ... 1,260 °C, 32 ... 2,300 °F
Measuring location	Ungrounded or grounded
Process connection	Surface mounting, welded/shielded
Data sheet	TE 65.60



**TC59-E**  
eTEFRACTO-PAD®  
Tubeskin thermocouple assembly

Sensor element	Types K, J, N, E
Measuring range	0 ... 1,260 °C, 32 ... 2,300 °F
Measuring location	Ungrounded or grounded
Process connection	Surface mounting, extractable/shielded
Data sheet	TE 65.61



**TC59-V**  
V-PAD®  
Tubeskin thermocouple assembly

Sensor element	Types K, J, N, E
Measuring range	-25 ... +400 °C, -13 ... + 752 °F
Measuring location	Ungrounded
Process connection	Surface mounting, welded
Data sheet	TE 65.59

# Thermocouples

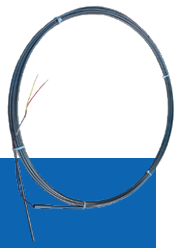

## TCC

Linear sensor for hot spot detection

Sensor element	Type K thermocouple wires
Measuring range	0 ... 400 °C, 32 ... 752 °F
Special feature	<ul style="list-style-type: none"> <li>■ Continuous monitoring</li> <li>■ Self-restoring</li> <li>■ Passive element</li> </ul>
Data sheet	TE 64.40



## TC80

High-temperature thermocouple

Sensor element	Types S, R, B, K, N or J
Measuring range	0 ... 1,700 °C, 32 ... 3,092 °F
Measuring location	Ungrounded
Process connection	Stop flange, threaded bushing
Data sheet	TE 65.80



## TC81

For flue gas temperature measurements

Sensor element	Types K, N or J
Measuring range	0 ... 1,200 °C, 32 ... 2,192 °F
Measuring location	Ungrounded or grounded
Process connection	Stop flange, threaded bushing
Data sheet	TE 65.81



## TC82

High-temperature thermocouple

Sensor element	Types K, J, E, N, S, R or B
Measuring range	0 ... 1,700 °C, 32 ... 3,092 °F
Thermowell	C610, C799
Data sheet	TE 65.82



## TC83

Sapphire-design thermocouple

Sensor element	Types K, N, S, R or B
Measuring range	0 ... 1,700 °C, 32 ... 3,092 °F
Thermowell	Sapphire (monocrystalline)
Data sheet	TE 65.83



## TC84

Sapphire-design thermocouple

Sensor element	Types S, R, B
Measuring range	0 ... 1,700 °C, 32 ... 3,092 °F
Thermowell	Sapphire (monocrystalline)
Case	Highest safety thanks to 2-chamber system
Data sheet	TE 65.84





**TC90**  
High-pressure thermocouple



Sensor element	Types K, J or E
Measuring range	0 ... 350 °C, 32 ... 662 °F
Measuring tip	Ungrounded or grounded
Process connection	Various high-pressure connections
Data sheet	TE 65.90



**TC95**  
Multipoint thermocouple



Sensor element	Types K, J, E, N or T
Measuring range	0 ... 1,200 °C, 32 ... 2,192 °F
Measuring tip	Ungrounded or grounded
Process connection	Various process connections
Data sheet	TE 70.01



**TC96-R**  
Flexible multipoint thermocouple

Sensor element	Types K, J, E or N
Measuring range	0 ... 1,200 °C, 32 ... 2,192 °F
Measuring tip	Ungrounded or grounded
Process connection	Various process connections
Data sheet	TE 70.10

# Resistance thermometers

Resistance thermometers are equipped with platinum sensor elements which change their electrical resistance as a function of temperature. In our range of products you will find resistance thermometers with connected cable as well as versions with connection head. A temperature transmitter can be installed directly in the connection head.

Resistance thermometers are suitable for applications between -196 ... +600 °C, -320 ... +1,112 °F (dependent on instrument model, sensor element, accuracy class and wetted materials).

Resistance thermometers are available in classes AA, A and B in accordance with IEC 60751.



**TR10-A**  
Measuring insert,  
MIMS cable



Sensor element	1 x Pt100, 2 x Pt100
Measuring range	-196 ... +600 °C, -320 ... +1,112 °F
Connection method	2-, 3- and 4-wire
Measuring insert	MIMS cable
Data sheet	TE 60.01



**TR10-B**  
For additional thermowell



Sensor element	1 x Pt100, 2 x Pt100
Measuring range	-196 ... +600 °C, -320 ... +1,112 °F
Connection method	2-, 3- and 4-wire
Measuring insert	MIMS cable
Data sheet	TE 60.02



**TR10-C**  
Threaded, with protection tube



Sensor element	1 x Pt100, 2 x Pt100
Measuring range	-196 ... +600 °C, -320 ... +1,112 °F
Connection method	2-, 3- and 4-wire
Process connection	Mounting thread
Data sheet	TE 60.03



**TR10-D**  
Threaded, miniature design



Sensor element	1 x Pt100, 2 x Pt100
Measuring range	-196 ... +500 °C, -320 ... +932 °F
Connection method	2-, 3- and 4-wire
Process connection	Mounting thread
Data sheet	TE 60.04



**TR10-F**  
Flanged resistance thermometer,  
with protection tube



Sensor element	1 x Pt100, 2 x Pt100
Measuring range	-196 ... +600 °C, -320 ... +1,112 °F
Connection method	2-, 3- and 4-wire
Process connection	Flange
Data sheet	TE 60.06



**TR10-H**  
Without thermowell



Sensor element	1 x Pt100, 2 x Pt100
Measuring range	-196 ... +600 °C, -320 ... +1,112 °F
Connection method	2-, 3- and 4-wire
Process connection	Mounting thread
Measuring insert	MIMS cable
Data sheet	TE 60.08



**TR10-J**  
Threaded, with perforated thermowell

Sensor element	1 x Pt100, 2 x Pt100
Measuring range	-196 ... +600 °C, -320 ... +1,112 °F
Connection method	2-, 3- and 4-wire
Measuring insert	MIMS cable
Process connection	Mounting thread
Data sheet	TE 60.10



**TR11-A**  
Measuring insert, tubular design

Sensor element	1 x Pt100, 2 x Pt100
Measuring range	-50 ... +250 °C, -58 ... +482 °F
Connection method	2-, 3- and 4-wire
Measuring insert	Tubular design
Data sheet	TE 60.13



**TR10-K**  
Measuring insert, for installation in TR10-L

Sensor element	1 x Pt100, 2 x Pt100
Measuring range	-196 ... +600 °C, -320 ... +1,112 °F
Connection method	2-, 3- and 4-wire
Measuring insert	MIMS cable
Data sheet	TE 60.11



**TR10-L**  
Flameproof enclosure, for additional thermowell

Sensor element	1 x Pt100, 2 x Pt100
Measuring range	-196 ... +600 °C, -320 ... +1,112 °F
Connection method	2-, 3- and 4-wire
Measuring insert	MIMS cable
Data sheet	TE 60.12



**TR12-A**  
Measuring insert for process resistance thermometer TR12-B

Sensor element	1 x Pt100, 2 x Pt100
Measuring range	-196 ... +600 °C, -320 ... +1,112 °F
Connection method	2-, 3- and 4-wire
Measuring insert	MIMS cable
Data sheet	TE 60.16



**TR12-B**  
Process resistance thermometer, for additional thermowell

Sensor element	1 x Pt100, 2 x Pt100
Measuring range	-196 ... +600 °C, -320...+1,112 °F
Connection method	2-, 3- and 4-wire
Measuring insert	MIMS cable
Option	Ex i, Ex d
Data sheet	TE 60.17



**TR12-M**  
Process resistance thermometer, basic module

Sensor element	1 x Pt100, 2 x Pt100
Measuring range	-196 ... +600 °C, -320 ... +1,112 °F
Connection method	2-, 3- and 4-wire
Measuring insert	MIMS cable
Option	Ex i, Ex d
Data sheet	TE 60.17



# Resistance thermometers

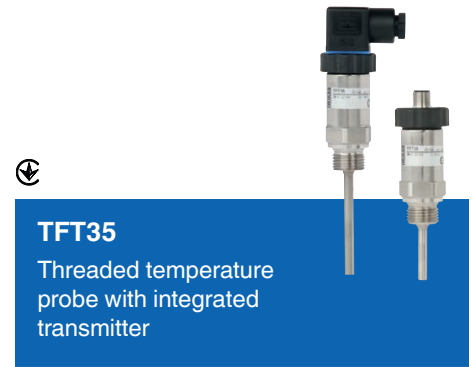

**TFT35**  
Threaded temperature probe with integrated transmitter

Measuring range	-50 ... +200 °C
Special feature	<ul style="list-style-type: none"> <li>■ Output signal 4 ... 20 mA, 0 ... 10 V, 0.5 ... 4.5 V</li> <li>■ Factory configured</li> <li>■ Measuring insert exchangeable</li> <li>■ Electr. connection via plug connection</li> </ul>
Data sheet	TE 76.18



**TR36**  
Compact version



Sensor element	1 x Pt100, 1 x Pt1000
Measuring range	-50 ... +250 °C, -58 ... +482 °F
Output	Pt100, 4 ... 20 mA
Data sheet	TE 60.36



**TR31**  
OEM miniature design



Sensor element	1 x Pt100, 1 x Pt1000
Measuring range	-50 ... +250 °C, -58 ... +482 °F
Output	Pt100, Pt1000, 4 ... 20 mA
CSA	Ordinary and hazardous locations
Data sheet	TE 60.31



**TR33**  
Miniature design, standard version



Sensor element	1 x Pt100, 1 x Pt1000
Measuring range	-50 ... +250 °C, -58 ... +482 °F
Output	Pt100, Pt1000, 4 ... 20 mA
CSA	Ordinary locations
Data sheet	TE 60.33



**TR34**  
Miniature design, explosion-protected



Sensor element	1 x Pt100, 1 x Pt1000
Measuring range	-50 ... +250 °C, -58 ... +482 °F
Output	Pt100, Pt1000, 4 ... 20 mA
CSA	Hazardous locations
Data sheet	TE 60.34



**TR40**  
Cable resistance thermometer, MIMS cable

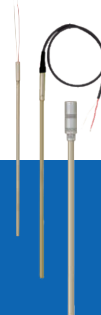

Sensor element	1 x Pt100, 2 x Pt100
Measuring range	-196 ... +600 °C, -320 ... +1,112 °F
Connection method	2-, 3- and 4-wire
Cable	Silicone, PTFE, PFA
Data sheet	TE 60.40



**TR41**  
Cable resistance thermometer Tubular design



Sensor element	1 x Pt100, 2 x Pt100
Measuring range	-60 ... +250 °C, -76 ... +482 °F
Connection method	2-, 3- and 4-wire
Cable	Silicone, PTFE, PFA
Data sheet	TE 60.41



**TR50**  
Surface resistance thermometer

Sensor element	1 x Pt100, 2 x Pt100
Measuring range	-196 ... +600 °C, -320 ... +1,112 °F
Connection method	2-, 3- and 4-wire
Process connection	Surface mounting
Data sheet	TE 60.50



**TR53**  
Bayonet resistance thermometer

Sensor element	1 x Pt100, 2 x Pt100
Measuring range	-196 ... +400 °C, -320 ... +752 °F
Connection method	2-, 3- and 4-wire
Process connection	Bayonet
Data sheet	TE 60.53



**TR55**  
With spring-loaded tip

Sensor element	1 x Pt100, 2 x Pt100
Measuring range	-196 ... +500 °C, -320 ... +932 °F
Connection method	2-, 3- and 4-wire
Process connection	Compression fitting
Data sheet	TE 60.55



**TR57-M**  
Pipe surface resistance thermometer for clamping

Sensor element	1 x Pt100
Measuring range	-20 ... +150 °C, -4 ... +302 °F
Connection method	Pt100 3-wire, 4 ... 20 mA
Data sheet	TE 60.57



**TR60**  
Indoor and outdoor resistance thermometer

Sensor element	1 x Pt100, 2 x Pt100
Measuring range	-40 ... +80 °C, -40 ... +176 °F
Connection method	2-, 3- and 4-wire
Process connection	Wall mounting
Data sheet	TE 60.60



**TR75**  
DiwiTherm® with digital indicator

Measuring range	-40.0 ... +199.9 °C, +200 ... +450 °C with automatic measuring range changeover (autorange)
Power supply	Battery operation
Data sheet	TE 60.75



**TR81**  
For flue gas temperature measurements

Sensor element	1 x Pt100, 2 x Pt100
Measuring range	-196 ... +600 °C, -320 ... +1,112 °F
Connection method	2-, 3- and 4-wire
Thermowell	Metal
Data sheet	TE 60.81



**TR95**  
Multipoint resistance thermometer

Sensor	Pt100
Measuring range	-196 ... +600 °C, -320 ... +1,112 °F
Connection method	2-, 3- and 4-wire
Process connection	Various process connections
Data sheet	TE 70.01

# Resistance thermometers



## TF35

Threaded temperature probe with plug connection

Measuring range	-50 ... +250 °C
Measuring element	Pt1000, Pt100, NTC, KTY
Special feature	<ul style="list-style-type: none"> <li>■ Very high vibration resistance</li> <li>■ Compact design</li> <li>■ Electrical connection via plug connection</li> </ul>
Data sheet	TE 67.10



## TF37

Threaded temperature probe with connection lead

Measuring range	-50 ... +260 °C
Measuring element	Pt100, Pt1000, NTC, KTY, Ni1000
Special feature	<ul style="list-style-type: none"> <li>■ High vibration resistance</li> <li>■ Connection lead made of PVC, silicone, PTFE</li> <li>■ Brass or stainless steel thermowell</li> </ul>
Data sheet	TE 67.12



## TF41

Temperature probe for outdoor temperature measurement

Measuring range	-40 ... +100 °C
Measuring element	Pt100, Pt1000, NTC
Special feature	<ul style="list-style-type: none"> <li>■ Smallest case design, UV-resistant</li> <li>■ Protected against dust and water jets, IP65</li> <li>■ Clip-on sun protector</li> </ul>
Data sheet	TE 67.17



## TF-2000

Cable temperature probe for heating and refrigeration technology

Measuring range	-50 ... +120 °C
Measuring element	Pt100, Pt1000, NTC
Special feature	<ul style="list-style-type: none"> <li>■ Permanently protected against condensation</li> <li>■ Cost savings thanks to quick assembly</li> <li>■ Delivery reliability, even for large orders</li> </ul>
Data sheet	TE 67.40

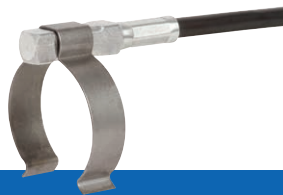

## TF44

Cable temperature probe for tubeskin measurement

Measuring range	-50 ... +200 °C
Measuring element	Pt100, Pt1000, NTC, KTY
Special feature	<ul style="list-style-type: none"> <li>■ Connection lead from PVC, silicone</li> <li>■ Aluminium probe sleeve</li> <li>■ Protected against dust and water jets, IP65</li> <li>■ With quick-mounting bracket</li> </ul>
Data sheet	TE 67.14



## TF45

Cable temperature probe for general industrial applications

Measuring range	-50 ... +260 °C
Measuring element	Pt100, Pt1000, NTC, KTY, Ni1000
Special feature	<ul style="list-style-type: none"> <li>■ Connection lead made of PVC, silicone, PTFE</li> <li>■ Probe sleeve from stainless steel</li> <li>■ Protected against dust and water jets, IP65</li> </ul>
Data sheet	TE 67.15

# Temperature transmitters



**T15**  
Digital temperature transmitter for resistance sensors

Input	Resistance thermometers, potentiometers
Accuracy	< 0.1 %
Output	4 ... 20 mA
Special feature	The fastest and simplest configuration on the market
Data sheet	TE 15.01



**T16**  
Digital temperature transmitter for thermocouples

Input	All commercially available thermocouples
Accuracy	Typical < 2 K
Output	4 ... 20 mA
Special feature	The fastest and simplest configuration on the market
Data sheet	TE 16.01



**T38**  
HART® temperature transmitter

Input	Universal use for 1 or 2 sensors: resistance thermometers (up to 2 x 3-wire), thermocouples, potentiometers, reed chains
Accuracy	< 0.1 %
Output	4 ... 20 mA, HART® protocol
Special feature	TÜV-certified SIL version (full assessment), True Drift Detection technology
Data sheet	TE 38.01



**T32**  
HART® temperature transmitter

Input	Resistance thermometers, thermocouples, potentiometers
Accuracy	< 0.1 %
Output	4 ... 20 mA, HART® protocol
Special feature	TÜV-certified SIL version (full assessment)
Data sheet	TE 32.04



**T91**  
Analogue temperature transmitter 3-wire, 0 ... 10 V

Input	Resistance thermometers, thermocouples
Accuracy	< 0.5 or < 1 %
Output	0 ... 10 V, 0 ... 5 V
Special feature	Fixed measuring range
Data sheet	TE 91.01, TE 91.02



**TIF50, TIF52**  
HART® field temperature transmitter

Input	Resistance thermometers, thermocouples, potentiometers
Accuracy	< 0.1 %
Output	4 ... 20 mA, HART® protocol
Special feature	PC configurable
Data sheet	TE 62.01

# Temperature switches

## Temperature switches for industrial applications



**TSD-30**  
Electronic temperature switch with display

Measuring range	-20 ... +80 °C, -20 ... +120 °C, 0 ... 150 °C
Output	<ul style="list-style-type: none"> <li>■ Switching outputs PNP or NPN</li> <li>■ 4 ... 20 mA</li> <li>■ 0 ... 10 V</li> <li>■ IO-Link 1.1</li> </ul>
Data sheet	TE 67.03



**TFS35**  
Bimetal temperature switch for switching voltages to 48 V

Switching temperature	50 ... 155 °C, fixed
Special feature	<ul style="list-style-type: none"> <li>■ Switching voltage to AC 48 V, DC 24 V</li> <li>■ Compact version: Normally closed (NC), normally open (NO)</li> <li>■ Electr. connection via plug connection</li> </ul>
Data sheet	TV 35.01



**TFS135**  
Bimetal temperature switch for switching voltages to 250 V

Switching temperature	50 ... 130 °C, fixed
Special feature	<ul style="list-style-type: none"> <li>■ Switching voltages to AC 250 V</li> <li>■ Contact version normally closed (NC)</li> <li>■ Electr. connection via plug connection</li> <li>■ 1 or 2 switch contacts</li> <li>■ Option: With measuring element Pt1000 / Pt100</li> </ul>
Data sheet	TV 35.02

## Temperature switches for the process industry



**TXS, TXA**  
Mini temperature switches

Setting range	-15 ... +20 to 180 ... 250 °C
Ignition protection type	Ex ia or Ex d
Switch	1 x SPDT
Switching power	AC 220 V/5 A DC 24 V/5 A
Data sheet	TV 31.70, TV 31.72



**TCS, TCA**  
Compact temperature switches

Setting range	-30 ... +10 to 160 ... 250 °C
Ignition protection type	Ex ia or Ex d
Switch	1 x SPDT or 1 x DPDT
Switching power	AC 250 V/15 A DC 24 V/2 A
Data sheet	TV 31.64, TV 31.65



**TWG, TAG**  
Heavy-duty version

Setting range	-30 ... +70 to 0 ... 600 °C
Ignition protection type	Ex ia or Ex d
Switch	1 or 2 SPDT or 1x DPDT
Switching power	AC 250 V/20 A DC 24 V/2 A
Data sheet	TV 31.60, TV 31.61



# Thermometers with switch contacts



## SC15

Expansion thermometer with microswitch, indicating temperature controller

Nominal size 60, 80, 100 mm  
72 x 72, 96 x 96 mm

Scale range -100 ... +400 °C

Wetted parts Copper alloy

Option Sheet steel version

Data sheet TV 28.02



## SB15

Expansion thermometer with microswitch, safety temperature limiter

Nominal size 60, 80, 100 mm  
72 x 72, 96 x 96 mm

Scale range 0 ... 400 °C

Wetted parts Copper alloy

Option Sheet steel version

Data sheet TV 28.03



## TGS55

Bimetal thermometer, stainless steel version

Nominal size 100 mm

Scale range -70 ... +30 to 0 ... 600 °C

Wetted parts Stainless steel

Option Liquid damping to max. 250 °C (case and probe)

Data sheet TV 25.01



## TGS73

Gas-actuated thermometer, stainless steel version

Nominal size 100, 160 mm

Scale range -200 ... +100 to 0 ... 700 °C

Wetted parts Stainless steel

Option ■ Capillary  
■ Liquid damping (case)

Data sheet TV 27.01



## 70 with 8xx

Expansion thermometer with microswitch

Nominal size 100 mm

Scale range -60 ... +40 to 0 ... 250 °C

Wetted parts Stainless steel

Option Various contact versions

Data sheet TV 28.01

# Temperature controllers



## CS4R

For rail mounting, 22.5 x 75 mm

Input	Multi-function input for resistance thermometers, thermocouples and standard signals
Control mode	PID, PI, PD, P, ON/OFF (configurable)
Monitoring output	Relay or logic level DC 0/12 V to control an electronic switch relay (SSR) or analogue current signal 4 ... 20 mA
Auxiliary power	<ul style="list-style-type: none"> <li>■ AC 100 ... 240 V</li> <li>■ AC/DC 24 V</li> </ul>
Data sheet	AC 85.05



## CS6S, CS6H, CS6L

For panel mounting, 48 x 48, 48 x 96, 96 x 96 mm

Input	Multi-function input for resistance thermometers, thermocouples and standard signals
Control mode	PID, PI, PD, P, ON/OFF (configurable)
Monitoring output	Relay (AC 250 V, 3A, (R) or 1A (L)) or logic level DC 0/12 V for 3-point control to control an electronic switch relay (SSR) or analogue current signal 4 ... 20 mA
Auxiliary power	<ul style="list-style-type: none"> <li>■ AC 100 ... 240 V</li> <li>■ AC/DC 24 V</li> </ul>
Data sheet	AC 85.08

# Accessories



## TND

Display for T38 temperature transmitter

Input	4 ... 20 mA
Dimensions	Ø 44 mm
Scale range	13.5 x 28 mm
Special feature	<ul style="list-style-type: none"> <li>■ 5-digit main measured value display</li> <li>■ 2 variants: with clip-on adapter or remote for mounting in the connection head cover</li> </ul>
Data sheet	TE 38.01



## IR80

Installation rods

- For installation of high-temperature thermocouples
- Suited for horizontal and vertical installation
- Can be used with flanged thermocouples
- Combines high mechanical stability and low weight



## PP82

Purge-gas control panel

- Heavy-duty stainless steel version
- High mechanical stability through side protection
- For wall and pipe mounting, 2"
- Pressure gauge with liquid damping
- Data sheet AC 80.19

# Accessories



## PU-548

Programming unit for temperature transmitters

- LED status display
- Compact design
- No further voltage supply needed, neither for the programming unit nor for the transmitter
- Due to the magWIK quick connector, fast connection to the transmitter possible
- Data sheet AC 80.18



## magWIK

Magnetic quick connector

- For accelerated connection for all configuration and calibration processes
- Connection of 2-mm plug contacts or 4-mm plug contacts with adapter
- Data sheet AC 80.15



## 905

Contact protection relay for model 821 switch contacts

- |             |  |
|-------------|--|
| Application | For optimal contact protection and highest switching reliability |
| Data sheet  | AC 08.05   |



## 904

Control unit for inductive contacts

- |             |   |
|-------------|---|
| Application | For operating measuring instruments with inductive contacts |
| Data sheet  | AC 08.04  |



## Coupler connector



## Fittings

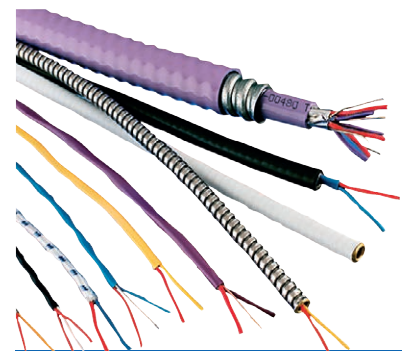

## Wires and cables

# Thermowells / Protection tubes

Whether in aggressive or abrasive process media, whether in high- or low-temperature ranges: For electrical or mechanical thermometers, to prevent direct exposure of their temperature probes to the medium, thermowells / protection tubes that suit each application are available. Thermowells / Protection tubes can be machined from bar stock material or assembled from tube sections and can either be screw-, weld- or flange-fitted.

They are offered in standard and special materials such as stainless steel 1.4571, 316L, Hastelloy® or titanium. Each version, depending on its construction type and its mounting to the process, has certain advantages and drawbacks with respect to its load limits and the special materials that can be used.

In order to manufacture thermowells / protection tubes for flange mounting at low cost from special materials, the designs used differ from standard thermowells/protection tubes in accordance with DIN 43772.

Thus, only the wetted parts of the thermowell / protection tube are manufactured from special materials, whereas the non-wetted flange is made of stainless steel and is welded to the special material.

This design is used both for protection tubes and thermowells. With tantalum as special material a removable jacket is used, which is slid over the supporting thermowell / protection tube from stainless steel.



**TW10**  
Thermowell with flange

Thermowell form	Tapered, straight or stepped
Nominal width	■ ASME 1 ... 4 inch DIN/EN ■ DN 25 ... 100
Pressure rating	ASME to 2,500 lb (DIN/EN to PN 100)
Data sheet	TW 95.10, TW 95.11, TW 95.12



**TW15**  
Threaded thermowell

Thermowell form	Tapered, straight or stepped
Head design	Hexagon, round with hexagon, or round with spanner flats
Process connection	½, ¾ or 1 NPT
Data sheet	TW 95.15



**TW20**  
Weld-in thermowell for welding socket

Thermowell form	Tapered, straight or stepped
Welding diameter	1.050, 1.315 or 1.900 inch (26.7, 33.4 or 48.3 mm)
Pressure rating	3,000 or 6,000 psi
Data sheet	TW 95.20



**TW25**  
Weld-in thermowell

Thermowell form	Tapered, straight or stepped
Bar diameter	Up to 2 inch (50.8 mm)
Data sheet	TW 95.25



**TW30**  
Vanstone, thermowell for lap flanges

Thermowell form	Tapered, straight or stepped
Nominal width	ASME 1, 1½ or 2 inch
Pressure rating	ASME up to 2,500 lbs
Data sheet	TW 95.30

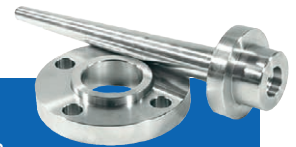

**TW31**  
Vanstone design  
in accordance with petrochemical  
standard

Thermowell form	In accordance with Shell drawings S38.113 and S38.114
Material	Stainless steel, special alloys
Flange	Slip-on flanges per ASME B16.5
Data sheet	TW 95.31



**ScrutonWell®**  
Thermowells  
in ScrutonWell® design

Thermowell form Bar stock material or with welded-on helix

Process connection Flange, threaded or weld-in

Material Stainless steel or special materials

Data sheet SP 05.16



**TW35**  
Threaded protection  
tube (DIN 43772 form 2, 2G, 3, 3G)

Protection tube form Form 2, 2G, 3 or 3G

Material Stainless steel

Connection to  
thermometer M24 x 1.5 rotatable

Data sheet TW 95.35



**TW40**  
Protection tube with flange  
(DIN 43772 form 2F, 3F)

Protection tube form Form 2F or 3F

Nominal width ■ DIN/EN DN 25 ... 50  
■ ASME 1 ... 2 inch

Pressure rating ■ DIN/EN up to PN 100  
■ ASME up to 1,500 psig

Data sheet TW 95.40



**TW45**  
Threaded protection tube (DIN 43772  
form 5, 8)

Protection tube form Form 5 or 8

Material Stainless steel

Data sheet TW 95.45



**TW50**  
Threaded thermowell (DIN 43772 form  
6, 7, 9)

Thermowell form Form 6, 7 or 9

Data sheet TW 95.50



**TW55**  
Thermowell for weld-in or  
with flange (DIN 43772 form 4, 4F)

Thermowell form Form 4 or 4F

Nominal width ■ DIN/EN DN 25 ... 50  
■ ASME 1 ... 2 inch

Pressure rating ■ DIN/EN up to PN 100  
■ ASME up to 2,500 psig

Data sheet TW 95.55

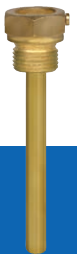

**SWT52G, SWT52S**  
Protection tube for model 52

Connection to  
thermometer Suitable for thermometers with plain  
connection (without thread), collar Ø 18  
mm, stem 8 and 13 mm

Protection tube  
material Copper alloy, St35 or stainless steel

Process connection G ½ B thread

Max. process  
temperature, pro-  
cess pressure ■ 160 °C with copper alloy as protection  
tube material (6 bar stat.)  
■ 500 °C with St35 stainless steel as  
protection tube material (25 bar stat.)

Data sheet TW 90.11

# Bypass level indicators

## Continuous level measurement via visual indication of the level without auxiliary power

### Applications

- Continuous level indication without auxiliary power
- Indication of the level proportional to height
- Individual design and corrosion-resistant materials make the products suitable for a broad range of applications
- Chemical industry, petrochemical industry, oil and natural gas extraction (on- and offshore), shipbuilding, machine building, power generating equipment, power plants
- Process water and drinking water treatment, food and beverage industry, pharmaceutical industry



### Special features

- Process- and procedure-specific production
- Operating limits:
  - Operating temperature:  $T = -196 \dots +450 \text{ }^\circ\text{C}$
  - Operating pressure:  $P = \text{vacuum to } 400 \text{ bar}^1$
  - Limit density:  $\rho \geq 340 \text{ kg/m}^3$
- Wide variety of different process connections and materials
- Mounting of level transmitters and magnetic switches possible as an option
- Explosion-protected versions

<sup>1)</sup> Individual limit values. For application limits, the joint consideration of temperature and pressure is required.



<b>BNA-S</b> Standard version	
Chamber	<ul style="list-style-type: none"> <li>■ <math>\text{Ø } 60.3 \times 2 \text{ mm}</math></li> <li>■ <math>\text{Ø } 60.3 \times 2.77 \text{ mm}</math></li> </ul>
Material	<ul style="list-style-type: none"> <li>■ Stainless steel 1.4571/316Ti</li> <li>■ 1.4401/1.4404 (316/316L)</li> </ul>
Process connection	<ul style="list-style-type: none"> <li>■ Flange DIN, ANSI, EN</li> <li>■ Thread</li> <li>■ Weld stub</li> </ul>
Pressure	Max. 100 bar
Temperature	$-196 \dots +450 \text{ }^\circ\text{C}$
Data sheet	LM 10.01



<b>BNA-H</b> High-pressure version	
Chamber	<ul style="list-style-type: none"> <li>■ <math>\text{Ø } 60.3 \times 3.91 \text{ mm}</math></li> <li>■ <math>\text{Ø } 60.3 \times 5.54 \text{ mm}</math></li> <li>■ <math>\text{Ø } 73 \times 7.01 \text{ mm}</math></li> <li>■ <math>\text{Ø } 76.1 \times 5 \text{ mm}</math></li> <li>■ <math>\text{Ø } 71 \times 7.5 \text{ mm}</math></li> <li>■ <math>\text{Ø } 76 \times 10 \text{ mm}</math></li> </ul>
Material	■ 1.4401/1.4404 (316/316L)
Process connection	<ul style="list-style-type: none"> <li>■ Flange DIN, ANSI, EN</li> <li>■ Thread</li> <li>■ Weld stub</li> </ul>
Pressure	Max. 385 bar
Temperature	$-196 \dots +450 \text{ }^\circ\text{C}$
Data sheet	LM 10.01

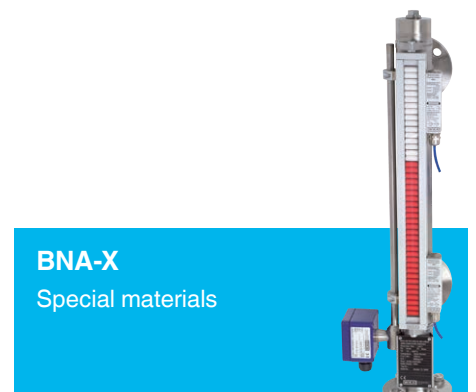

<b>BNA-X</b> Special materials	
Chamber	<ul style="list-style-type: none"> <li>■ <math>\text{Ø } 60.3 \times 2 \text{ mm}</math></li> <li>■ <math>\text{Ø } 60.3 \times 2.77 \text{ mm}</math></li> <li>■ <math>\text{Ø } 60.3 \times 3.91 \text{ mm}</math></li> <li>■ <math>\text{Ø } 60.3 \times 5.54 \text{ mm}</math></li> </ul>
Material	<ul style="list-style-type: none"> <li>■ Titanium 3.7035</li> <li>■ Hastelloy C276</li> <li>■ 6Mo 1.4547</li> <li>■ Monel</li> <li>■ Inconel</li> </ul>
Process connection	<ul style="list-style-type: none"> <li>■ Flange DIN, ANSI, EN</li> <li>■ Thread</li> <li>■ Weld stub</li> </ul>
Pressure	Max. 250 bar
Temperature	$-196 \dots +450 \text{ }^\circ\text{C}$
Data sheet	LM 10.01

### BNA-P

Plastic version



Chamber	Ø 60.3 x 3 mm
Material	<ul style="list-style-type: none"> <li>■ PVDF</li> <li>■ PP</li> </ul>
Process connection	Flange DIN, ANSI, EN
Pressure	Max. 6 bar
Temperature	-10 ... +100 °C
Data sheet	LM 10.01

### BNA-L

Liquid/KOplus version



Chamber	<ul style="list-style-type: none"> <li>■ Ø 88.9 x 2 mm</li> <li>■ Ø 88.9 x 2.9 mm</li> <li>■ 114 x 2</li> <li>■ 114 x 3.6</li> <li>■ 114 x 4.5</li> <li>■ 114 x 6.3</li> </ul>
Material	1.4401/1.4404 (316/316L)
Process connection	<ul style="list-style-type: none"> <li>■ Flange DIN, ANSI, EN</li> <li>■ Thread</li> <li>■ Weld stub</li> </ul>
Pressure	Max. 63 bar
Temperature	-196 ... +450 °C
Data sheet	LM 10.01

### BNA-SD, BNA-HD DUplus

Standard/High-pressure version



Chamber	<ul style="list-style-type: none"> <li>■ BNA-SD: Ø 60.3 x 2 mm</li> <li>          Ø 60.3 x 2.77 mm</li> <li>■ BNA-HD: Ø 60.3 x 3.91 mm</li> </ul>
Material	■ 1.4401/1.4404 (316/316L)
Process connection	<ul style="list-style-type: none"> <li>■ Flange DIN, ANSI, EN</li> <li>■ Thread</li> <li>■ Weld stub</li> </ul>
Pressure	<ul style="list-style-type: none"> <li>■ BNA-SD: max. 100 bar</li> <li>■ BNA-HD: max. 160 bar</li> </ul>
Temperature	-196 ... +450 °C
Data sheet	LM 10.01

## Accessories for bypass level indicators



### BLR

Reed level transmitter



Material	Stainless steel
Meter run	Max. 6,000 mm
Temperature	-100 ... +350 °C, depending on version
Output signal	4 ... 20 mA, HART®, PROFIBUS® PA or FOUNDATION™ Fieldbus
Data sheet	LM 10.03

### BMD

Magnetic indication



Material	Aluminium, anodised, stainless steel
Indication elements	Plastic rollers, stainless steel flaps
Cover	Polycarbonate, glass
Length	180 ... 6,000 mm
Temperature	-200 ... +450 °C
Data sheet	LM 10.03

### BFT

Float



Material	Stainless steel, titanium, various special materials
Pressure	To 450 bar
Temperature	-200 ... +450 °C
Density	> 340 kg/m <sup>3</sup>
Data sheet	LM 10.02

# Accessories for bypass

Combines the tried-and-trusted bypass with further independent measurement principles



**BLM-SI, BLM-SD**  
Magnetostrictive level transmitter, intrinsically safe (Ex i)

Material	Stainless steel 1.4404
Guide tube length	Max. 5,800 mm
Temperature	-60 ... +185 °C
Output signal	4 ... 20 mA, HART®
Data sheet	LM 10.05



**BLM-SF-FM**  
Magnetostrictive level transmitter with FM approval

Material	Stainless steel
Guide tube length	Max. 4,000 mm
Temperature	-200 ... +180 °C
Output signal	4 ... 20 mA, HART®
Data sheet	LM 10.05



**UTN**  
Top-mounted level indicator

Chamber	<ul style="list-style-type: none"> <li>■ Ø 42.4 x 2 mm (standard)</li> <li>■ Ø 42.2 x 2.77 mm</li> <li>■ Ø 60.3 x 2 mm</li> <li>■ Ø 60.3 x 2.77 mm</li> </ul>
Material	<ul style="list-style-type: none"> <li>■ Stainless steel 1.4571/316Ti</li> <li>■ Stainless steel 1.4401/1.4404 (316/316L)</li> </ul>
Process connection	Flange DIN, ANSI, EN
Pressure	Max. 40 bar
Temperature	-196 ... +300 °C
Data sheet	LM 11.02



**BLM-TA**  
High-temperature version

Material	Stainless steel
Guide tube length	Max. 6,000 mm
Temperature	<ul style="list-style-type: none"> <li>■ -40 ... +125 °C</li> <li>■ -90 ... +125 °C</li> <li>■ -45 ... +250 °C</li> <li>■ -45 ... +450 °C</li> </ul>
Output signal	4 ... 20 mA, HART® v6
Data sheet	LM 10.05



**BLM-TAI**  
High-temperature version, intrinsically safe

Material	Stainless steel
Guide tube length	Max. 6,000 mm
Temperature	<ul style="list-style-type: none"> <li>■ -40 ... +125 °C</li> <li>■ -40 ... +250 °C</li> <li>■ -40 ... +450 °C</li> </ul>
Output signal	4 ... 20 mA, HART® v6
Data sheet	LM 10.05



# External chambers

The external chamber model BZG consists of an external chamber vessel that is mounted laterally to a container using at least 2 process connections (flange, thread or weld stub). Through this type of arrangement, the level in the external chamber vessel cor-

responds to the level in the container. The level is measured by a measuring instrument inserted additionally in the external chamber vessel, for example model FLR or FLS, or by a guided wave radar.

## Applications

- Level detection for almost all liquid media
- Individual design and corrosion-resistant materials make the products suitable for a broad range of applications
- Chemical industry, petrochemical industry, oil and natural gas extraction (on- and offshore), shipbuilding, machine building, power generating equipment, power plants

## Special features

Process- and procedure-specific production

Operating limits: □ Operating temperature: T = -196 ... +450 °C  
□ Operating pressure: P = Vacuum to 400 bar <sup>1)</sup>

- Wide variety of different process connections and materials
- Mounting of level transmitters and guided wave radars possible as an option

<sup>1)</sup> Individual limit values. For application limits, the joint consideration of temperature and pressure is required.

### BZG-S

External chamber,  
standard version

Material

- Stainless steel 1.4571 (316Ti)
- Stainless steel 1.4401/1.4404 (316/316L)

Process connection Flange

- DIN EN 1092-1 DN 10 ... DN 100, PN 6 ... PN 63
- DIN DN 10 ... DN 100, PN 6 ... PN 64
- ANSI B16.5 ½" ... 4", class 150 ... 600

Pressure 64 bar

Temperature -196 ... +450 °C

Data sheet LM 11.01

### BZG-H

External chamber,  
high-pressure version

Material

- Stainless steel 1.4571 (316Ti)
- Stainless steel 1.4401/1.4404 (316/316L)

Process connection Flange

- DIN EN 1092-1 DN 10 ... DN 100, PN 100 ... PN 400
- DIN DN 10 ... DN 100, PN 100 ... PN 400
- ANSI B16.5 ½" ... 4", class 600 ... 2,500

Pressure 400 bar

Temperature -196 ... +450 °C

Data sheet LM 11.01

### BZG-K

External chamber,  
steel version

Material

- Steel 1.0345/1.0460
- Steel 1.5415 (16Mn3)
- A105/A106 Gr. B
- A350 LF2/A333 Gr. 6

Process connection Flange

- DIN EN 1092-1 DN 10 ... DN 50, PN 16 ... PN 400
- DIN DN 10 ... DN 50, PN 16 ... PN 400
- ANSI B16.5 ½" ... 4", class 150 ... 2,500

Pressure Max. 255 bar (material-dependent)

Temperature -10 ... +425 °C (material-dependent)

Data sheet LM 11.01

### BZG-X

External chamber,  
special material version

Material

- Stainless steel 6Mo 1.4547 (UNS S31254)
- Stainless steel 1.4306 (304L)
- Duplex 1.4462 (UNS S31803)
- Super Duplex 1.4410 (UNS S3850)
- Titanium 3.7035 (grade 2)
- Hastelloy C276 (2.4819)

Process connection Flange

- DIN EN 1092-1 DN 10 ... DN 100, PN 63 ... PN 400
- DIN DN 10 ... DN 100, PN 64 ... PN 400
- ANSI B16.5 ½" ... 4", class 600 ... 2,500

Pressure Max. 430 bar (material-dependent)

Temperature -196 ... +450 °C (material-dependent)

Data sheet LM 11.01

# Glass level gauges

## Direct level indication without auxiliary power

### Applications

- Continuous level indication without auxiliary power
- Direct indication of the level
- Individual design and corrosion-resistant materials make the products suitable for a broad range of applications
- Chemical industry, petrochemical industry, oil and natural gas extraction (on- and offshore), shipbuilding, machine building, power generating equipment, power plants
- Oil and gas, heat transfer and refrigeration systems, plants for cryogenics



### Special features

- Process- and procedure-specific production
- Operating limits:
  - Operating temperature:  $T = -196 \dots +374 \text{ °C}^1$
  - Operating pressure: vacuum to 250 bar <sup>1)</sup>
- Wide variety of different process connections and materials
- Illumination optional
- Heating and/or insulation optional

<sup>1)</sup> Individual limit values. For application limits, the joint consideration of temperature and pressure is required.



**LGG-E**  
Compact version

Type of indication	Reflex
Material	<ul style="list-style-type: none"> <li>■ Steel 1.0460</li> <li>■ A105, 1.0570</li> </ul>
Process connection	Flange DIN, ANSI, EN
Pressure	Max. 40 bar
Temperature	-10 ... +243 °C (steam)
Glass size	2 ... 11
Number of segments	1 ... 3
Data sheet	LM 33.01



**LGG-RP, LGG-TP**  
Carbon-Line version

Type of indication	Reflex/transparent
Material	Steel A350 LF2
Process connection	<ul style="list-style-type: none"> <li>■ Flange DIN, ANSI, EN</li> <li>■ Male thread 1/2" NPT, 3/4" NPT</li> <li>■ Weld stub 1/2", 3/4"</li> </ul>
Pressure	Max. 100 bar
Temperature	<ul style="list-style-type: none"> <li>■ -40 ... +243 °C (steam)</li> <li>■ -40 ... +300 °C</li> </ul>
Glass size	4 ... 9
Number of segments	1 ... 5
Data sheet	LM 33.01



**LGG-RE, LGG-TE**  
Standard version

Type of indication	Reflex/transparent
Material	<ul style="list-style-type: none"> <li>■ Steel 1.0570, A350 LF2</li> <li>■ Stainless steel 1.4404/316L</li> </ul>
Process connection	<ul style="list-style-type: none"> <li>■ Flange DIN, ANSI, EN</li> <li>■ Male thread 1/2" NPT, 3/4" NPT</li> <li>■ Weld stub 1/2", 3/4"</li> </ul>
Pressure	Max. 160 bar
Temperature	<ul style="list-style-type: none"> <li>■ -196 ... +243 °C (steam)</li> <li>■ -196 ... +300 °C</li> </ul>
Glass size	2 ... 11
Number of segments	1 ... 5 (others on request)
Data sheet	LM 33.01

**LGG-RI, LGG-TI**

High-pressure version

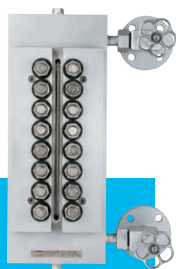

Type of indication	Reflex/transparent
Material	<ul style="list-style-type: none"> <li>■ Steel 1.5415</li> <li>■ Stainless steel 1.4404/316L</li> </ul>
Process connection	<ul style="list-style-type: none"> <li>■ Flange DIN, ANSI, EN</li> <li>■ Male thread ½" NPT, ¾" NPT</li> <li>■ Weld stub ½", ¾"</li> </ul>
Pressure	Max. 250 bar
Temperature	-196 ... +100 °C
Glass size	2 ... 9
Number of segments	1 ... 5
Data sheet	LM 33.01

**LGG-M**

Refraction version

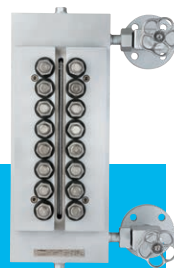

Type of indication	Refraction
Material	Steel 1.5415
Process connection	<ul style="list-style-type: none"> <li>■ Flange DIN, ANSI, EN</li> <li>■ Male thread G ½, G ¾, ½" NPT, ¾" NPT</li> <li>■ Weld stub ½", ¾"</li> </ul>
Pressure	Max. 250 bar
Temperature	-10 ... +374 °C
Glass size	2 ... 11
Number of segments	1 ... 9
Data sheet	LM 33.01

# Submersible pressure sensors

## Hydrostatic level measurement



### Applications

- Level measurement in rivers and lakes
- Control of sewage lift and pumping stations
- Monitoring of sewage, settling and rainwater retention basins
- Level measurement in vessel and storage systems for oils and fuels

### Special features

- Slimline and hermetically sealed design to 300 m water column
- Highly resistant versions available
- Explosion protection per ATEX, IECEx, FM and CSA
- Drinking water conformity per KTW and ACS
- Temperature output, HART® and low-power output signal for battery operation

### LS-1000

For general applications



Accuracy (± % of span) ≤ 0.5 or ≤ 1

Measuring range 0 ... 0.1 to 0 ... 1 bar  
0 ... 1.25 to 0 ... 2 bar abs.

Special feature ■ Levels from 1 to 10 m  
■ Permanently leak-tight  
■ Low total cost of ownership

Data sheet LM 40.05



### IL-10

For applications in hazardous areas



Accuracy (± % of span) ■ ≤ 0.5 or ≤ 0.25 (only applies to measuring ranges ≥ 0.25 bar (3.6 psi))

Measuring range 0 ... 0.1 to 0 ... 25 bar

Special feature ■ Suitable for all level measurements in hazardous areas  
■ Explosion protection per IECEx, ATEX and CSA  
■ Shipbuilding approval in accordance with GL

Data sheet PE 81.23



### LF-1

For demanding applications

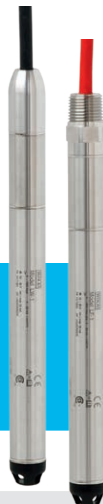

Accuracy (± % of span) ≤ 0.5 or ≤ 1

Measuring range 0 ... 0.1 to 0 ... 6 bar  
0 ... 1.6 to 0 ... 6 bar abs.

Special feature ■ Suitable for measurements in contaminated and aggressive media  
■ An optimised discharge behaviour and a large pressure port prevent the instrument from clogging and ensure a minimum maintenance effort  
■ Can be used in explosion-protected areas  
■ Developed for wireless applications

Data sheet LM 40.04



### LH-10

High-performance



Accuracy (± % of span) Measuring range: < 0.25 bar: ≤ ±0.50 %  
Measuring ranges: ≥ 0.25 bar: ≤ ±0.25 %

Measuring range ■ 0 ... 0.1 to 0 ... 25 bar

Special feature ■ Precise and reliable  
■ Integrated temperature measurement (option)  
■ Design from Hastelloy® and FEP cable for especially high resistance (optional)

Data sheet PE 81.09

# Continuous measurement with float for industrial applications

## With reed measuring chain

### Applications

- Level measurements of liquids in machine building
- Control and monitoring tasks for hydraulic power packs, compressors and cooling systems

### Special features

- Media compatibility: Oil, water, diesel, refrigerants and other liquids
- Permissible medium temperature: -30 ... +120 °C
- Output signals for level and temperature (optional) as resistance output signal or 4 ... 20 mA current output
- Accuracy, resolution: 24, 12, 10, 6 or 3 mm



### RLT-1000 Stainless steel version



Accuracy 24, 20, 12, 10, 6 or 3 mm

Output signal

- Resistance signal
- 4 ... 20 mA, 2-wire
- 0 ... 5 V, 3-wire
- 0 ... 10 V, 3-wire

Temperature -30 ... +80 °C  
(-30 ... +120 °C optional)

Guide tube length 150 ... 1,500 mm

Data sheet LM 50.02

### RLT-2000 Plastic version



Accuracy 24, 20, 12, 10, 6 or 3 mm

Output signal

- Resistance signal
- 4 ... 20 mA, 2-wire
- 0 ... 5 V, 3-wire
- 0 ... 10 V, 3-wire

Temperature -10 ... +80 °C  
(-30 ... +120 °C optional)

Guide tube length 150 ... 1,500 mm

Data sheet LM 50.01

### RLT-3000 Stainless steel version with temperature output signal



Accuracy 24, 20, 12, 10, 6 or 3 mm

Level output signal

- 4 ... 20 mA, 2-wire
- 0 ... 5 V, 3-wire
- 0 ... 10 V, 3-wire

Output signal Temperature Pt100 or Pt1000

Temperature -30 ... +100 °C

Guide tube length 150 ... 1,500 mm

Data sheet LM 50.05

# Continuous measurement with float for the process industry

## Magnetostrictive

### Applications

- High-accuracy level detection for almost all liquid media
- Chemical industry, petrochemical industry, natural gas, offshore, shipbuilding, machine building, power generating equipment, power plants
- Process water and drinking water treatment, food and beverage industry, pharmaceutical industry

### Special features

- Process- and procedure-specific solutions possible
- Operating limits:
  - Operating temperature:  $T = -90 \dots +450 \text{ }^\circ\text{C}$
  - Operating pressure:  $P = \text{vacuum to } 100 \text{ bar}$
  - Limit density:  $\rho \geq 400 \text{ kg/m}^3$
- Resolution  $< 0.1 \text{ mm}$
- Wide variety of different electrical connections, process connections and materials
- Explosion-protected versions



### FLM-S Stainless steel version

- Process connection ■ Mounting thread  
■ Flange: DIN, ANSI

Guide tube length Max. 6,000 mm

Pressure 0 ... 200 bar

Temperature -90 ... +450 °C

Density  $\geq 400 \text{ kg/m}^3$

Ingress protection IP66/68 per IEC/EN 60529

Data sheet LM 20.01



### FLM-CAI Compact version, intrinsically safe

- Process connection ■ Mounting thread downwards  
- G 1/2" ... G 2"  
- NPT 1/2" ... NPT 2"
- Mounting flange  
- ANSI 1/2" ... 2 1/2", class 150 ... 600  
- EN DN 20 ... DN 65, PN 6 ... PN 100  
- DIN DN 20 ... DN 65, PN 6 ... PN 100

Guide tube length ■ 100 ... 1,000 mm (Ø 6 mm guide tube)  
■ 100 ... 3,000 mm (Ø 12 mm guide tube)

Pressure Vacuum to 40 bar

Temperature -40 ... +250 °C

Density  $\geq 580 \text{ kg/m}^3$

Ingress protection IP68 per IEC/EN 60529

Data sheet LM 20.04

### FLM-CM Compact version for industrial applications

- Process connection ■ Mounting thread downwards  
- G 1/2" ... G 2"  
- NPT 1/2" ... NPT 2"

Guide tube length 100 ... 1,000 mm (Ø 6 mm guide tube)

Pressure Vacuum to 40 bar

Temperature -40 ... +125 °C

Density  $\geq 680 \text{ kg/m}^3$

Ingress protection IP68 per IEC/EN 60529

Data sheet LM 20.05

### FLM-CA Compact version for process applications

- Process connection ■ Mounting thread downwards  
- G 1/2" ... G 2"  
- NPT 1/2" ... NPT 2"
- Mounting flange  
- ANSI 1/2" ... 2 1/2", class 150 ... 600  
- EN DN 20 ... DN 65, PN 6 ... PN 100  
- DIN DN 20 ... DN 65, PN 6 ... PN 100

Guide tube length ■ 100 ... 1,000 mm (Ø 6 mm guide tube)  
■ 100 ... 3,000 mm (Ø 12 mm guide tube)

Pressure Vacuum to 40 bar

Temperature -40 ... +250 °C

Density  $\geq 580 \text{ kg/m}^3$

Ingress protection IP68 per IEC/EN 60529

Data sheet LM 20.04

**FLM-P**

Plastic version



Process connection ■ Mounting thread  
■ Flange DIN, ANSI

Guide tube length Max. 5,000 mm

Pressure 0 ... 16 bar

Temperature -10 ... +100 °C

Density ≥ 800 kg/m<sup>3</sup>

Ingress protection IP68 per IEC/EN 60529

Data sheet LM 20.01

**FLM-H**

Hygienic version, for sanitary applications



Process connection ■ Clamp ISO 2852  
■ Clamp DIN 32767  
■ Aseptic thread DIN 11864-1  
■ Aseptic liner DIN 11864-1  
■ Aseptic flange DIN 11864-2  
■ Aseptic clamp DIN 11864-3  
■ VARIVENT®  
■ BioConnect®

Material 1.4435 (316L) or 1.4404 (316L)

Guide tube length Max. 6,000 mm

Pressure 10 bar

Temperature -40 ... +250 °C

Density ≥ 770 kg/m<sup>3</sup>

Data sheet LM 20.01

**FLM-TAI**

High-temperature version, intrinsically safe

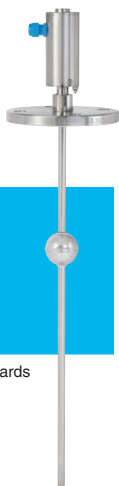

Process connection ■ Mounting thread downwards  
- G ½" ... G 2"  
- NPT ½" ... NPT 2"  
■ Mounting flange  
- ANSI ½" ... 2 ½",  
class 150 ... 600  
- EN DN 20 ... DN 65,  
PN 6 ... PN 100  
- DIN DN 20 ... DN 65,  
PN 6 ... PN 100

Guide tube length 100 ... 3,000 mm (Ø 12 mm guide tube)

Pressure Vacuum to 40 bar

Temperature -40 ... +450 °C

Density ≥ 400 kg/m<sup>3</sup>

Output signal 4 ... 20 mA, HART® v6

Ingress protection IP68 per IEC/EN 60529

Data sheet LM 20.01

# Continuous measurement with float for the process industry

## With reed measuring chain

### Applications

- Level detection for almost all liquid media
- Chemical industry, petrochemical industry, natural gas, offshore, shipbuilding, machine building, power generating equipment, power plants
- Process water and drinking water treatment, food and beverage industry, pharmaceutical industry



### Special features

- Process- and procedure-specific solutions possible
- Operating limits:
  - Operating temperature:  $T = -80 \dots +200 \text{ }^\circ\text{C}$
  - Operating pressure:  $P = \text{vacuum to } 80 \text{ bar}$
  - Limit density:  $\rho \geq 400 \text{ kg/m}^3$
- Wide variety of different electrical connections, process connections and materials
- Optionally with programmable and configurable head-mounted transmitter for 4 ... 20 mA field signals, HART®, PROFIBUS® PA and FOUNDATION™ Fieldbus
- Explosion-protected versions

**FLR-SA, FLR-SB**  
Stainless steel version

Process connection	<ul style="list-style-type: none"> <li>■ Mounting thread</li> <li>■ Flange DIN, ANSI, EN</li> </ul>
Guide tube length	Max. 6,000 mm
Pressure	0 ... 100 bar
Temperature	-80 ... +200 °C
Density	$\geq 400 \text{ kg/m}^3$
Ingress protection	To IP66/IP68 per IEC/EN 60529
Data sheet	LM 20.02

**FLR-SAI, FLR-SBI**  
Intrinsically safe

Process connection	<ul style="list-style-type: none"> <li>■ Mounting thread</li> <li>■ Flange DIN, ANSI, EN</li> </ul>
Guide tube length	Max. 6,000 mm
Pressure	0 ... 100 bar
Temperature	-80 ... +200 °C
Density	$\geq 400 \text{ kg/m}^3$
Ingress protection	To IP66/IP68 per IEC/EN 60529
Data sheet	LM 20.02

**FLR-F**  
Reed level transmitter for food applications

Process connection	<ul style="list-style-type: none"> <li>■ Threaded pipe connection DIN 11851, downwards, DN 50 ... DN 150</li> <li>■ Clamp pipe connection DIN 32676, DN 25 ... DN 100 or 1" ... 4"</li> <li>■ Clamp pipe connection ISO 2852, DN 25 ... DN 150</li> <li>■ Others on request</li> </ul>
Guide tube length	<ul style="list-style-type: none"> <li>■ Max. 1,500 mm (guide tube diameter 12 mm)</li> <li>■ Max. 3,500 mm (guide tube diameter 14 mm)</li> <li>■ Max. 6,000 mm (guide tube diameter 18 mm)</li> </ul>
Pressure	0 ... 25 bar
Temperature	Normal temperature: -20 ... +120 °C High temperature: +120 ... +200 °C Low temperature: -80 ... -20 °C
Density	$\geq 400 \text{ kg/m}^3$
Ingress protection	To IP66/IP68 per IEC/EN 60529
Data sheet	LM 20.06





## FLR-PA, FLR-PB

Plastic version, PP, PVDF, PP

Process connection ■ Mounting thread  
 ■ Flange DIN,  
 ANSI, EN

Guide tube length Max. 5,000 mm

Pressure 0 ... 3 bar

Temperature -10 ... +100 °C

Density  $\geq 800 \text{ kg/m}^3$

Data sheet LM 20.02



## FLR-HA3

Hygienic version, for  
 sanitary applications

Process connection ■ Clamp ISO 2852  
 ■ Clamp DIN 32767  
 ■ Aseptic thread DIN 11864-1  
 ■ Aseptic liner DIN 11864-1  
 ■ Aseptic flange DIN 11864-2  
 ■ Aseptic clamp DIN 11864-3  
 ■ VARIVENT®  
 ■ BioConnect®

Material 1.4435 (316L) or 1.4404 (316L)

Guide tube length Max. 6,000 mm

Pressure 10 bar

Temperature -40 ... +250 °C

Density  $\geq 770 \text{ kg/m}^3$

Ingress protection To IP66/IP68 per IEC/EN 60529

Data sheet LM 20.02



# Float switches for industrial applications

## Applications

- Level measurement of liquids in machine building
- Control and monitoring tasks for hydraulic power packs, compressors and cooling systems

## Special features

- Media compatibility: Oil, water, diesel, refrigerants and other liquids
- Permissible medium temperature range: -30 ... +150 °C
- Up to 4 switching outputs freely definable as normally open, normally closed or change-over contact
- Optional temperature output signal, selectable as preconfigured bimetal switch or either Pt100 or Pt1000



### RLS-1000 Stainless steel version

Switching output	Up to 4 (normally closed, normally open, change-over contact)
Medium temperature	-30 ... +80 °C (-30 ... +150 °C optional)
Guide tube length	60 ... 1,500 mm
Data sheet	LM 50.03

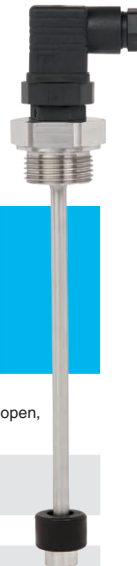

### RLS-2000 Plastic version

Switching output	Up to 4 (normally closed, normally open, change-over contact)
Medium temperature	-10 ... +80 °C (-30 ... +120 °C optional)
Guide tube length	70 ... 1,500 mm
Data sheet	LM 50.04



### RLS-3000 Stainless steel version, with temperature output signal

Switching output	Up to 3 (normally closed, normally open, change-over contact)
Temperature output	Normally closed, normally open, Pt100, Pt1000
Medium temperature	-30 ... +80 °C (-30 ... +150 °C optional)
Guide tube length	60 ... 1,500 mm
Data sheet	LM 50.06





**RLS-4000**  
Intrinsic safety Ex i

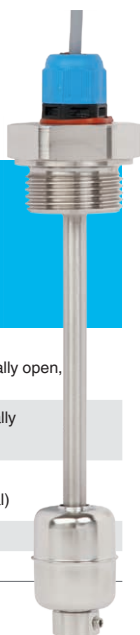

Switching output	Up to 4 (normally closed, normally open, change-over contact)
Temperature output (optional)	Normally closed, normally open, Pt100, Pt1000
Medium temperature	-30 ... +80 °C (-30 ... +150 °C optional)
Guide tube length	60 ... 1,500 mm
Data sheet	LM 50.07



**RLS-5000**  
For the shipbuilding industry (bilge water tanks)



Switching output	Normally closed, normally open, change-over contact
Medium temperature	-40 ... +80 °C
Electrical output	Marine cable, IP68
Test device	Optional
Data sheet	LM 50.08

**RLS-6000**  
For water and wastewater



Switching output	Normally closed, normally open, change-over contact
Density	≥ 1,000 kg/m <sup>3</sup>
Medium temperature	-10 ... +60 °C
Guide tube length	150 ... 1,000 mm
Data sheet	LM 50.09

**RLS-7000**  
Miniature design, vertical installation



Switching output	Normally closed, normally open, change-over contact
Medium temperature	-25 ... +80 °C (-25 ... 100 °C optional)
Wetted material:	<ul style="list-style-type: none"> <li>■ Polypropylene (PP)</li> <li>■ Polyamide PA6.6</li> <li>■ Polyamide PA12 (on request)</li> </ul>
Data sheet	LM 50.11

**RLS-8000**  
Miniature design, horizontal installation



Switching output	Normally closed, normally open, change-over contact
Medium temperature	-25 ... +80 °C (-25 ... 100 °C optional)
Wetted material:	<ul style="list-style-type: none"> <li>■ Polypropylene (PP)</li> <li>■ Polyamide PA6.6</li> <li>■ Polyamide PA12 (on request)</li> </ul>
Data sheet	LM 50.12

# Float switches for the process industry

## Robust switches for liquid media

### Applications

- Level detection for almost all liquid media
- Pump and level control and monitoring of distinct filling levels
- Chemical industry, petrochemical industry, natural gas, offshore, shipbuilding, machine building, power generating equipment, power plants
- Process water and drinking water treatment, food and beverage industry

### Special features

- Large range of application due to the simple, proven functional principle
- For harsh operating conditions, long service life
- Operating limits:
  - Operating temperature:  $T = -50 \dots +350 \text{ }^\circ\text{C}$
  - Operating pressure:  $P = \text{vacuum to } 40 \text{ bar}$
  - Limit density:  $\rho \geq 300 \text{ kg/m}^3$
- Wide variety of different electrical connections, process connections and materials
- Explosion-protected versions



<b>FLS-SA, FLS-SB</b>	
Stainless steel version, for vertical installation	
Switch points	Max. 8 switch points
Process connection	<ul style="list-style-type: none"> <li>■ Mounting thread</li> <li>■ Flange DIN, ANSI, EN</li> </ul>
Guide tube length	Max. 6,000 mm
Pressure	0 ... 40 bar
Temperature	-50 ... +300 °C
Density	$\geq 390 \text{ kg/m}^3$
Data sheet	LM 30.01

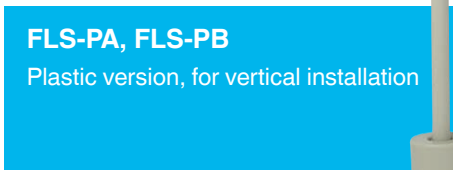

<b>FLS-PA, FLS-PB</b>	
Plastic version, for vertical installation	
Switch points	Max. 8 switch points
Process connection	<ul style="list-style-type: none"> <li>■ Mounting thread</li> <li>■ Flange DIN, ANSI, EN</li> </ul>
Guide tube length	Max. 5,000 mm
Pressure	0 ... 3 bar
Temperature	-10 ... +100 °C
Density	$\geq 400 \text{ kg/m}^3$
Data sheet	LM 30.01

**ELLS-S**For lateral mounting  
with external chamber

External chamber	Stainless steel
Process connection	Threaded pipe connection GE10-LR galvanised steel
Pressure	To 6 bar
Temperature	-30 ... +300 °C
Data sheet	LM 30.03

**ELLS-A**For lateral mounting  
with external chamber

External chamber	Aluminium
Process connection	Threaded pipe connection GE10-LR galvanised steel
Pressure	Max. 1 bar
Temperature	-30 ... +150 °C
Data sheet	LM 30.03

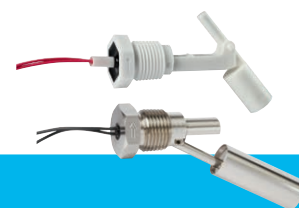
**HLS-M1,  
HLS-M2**Plastic or stainless steel version, with  
cable outlet

Process connection	<ul style="list-style-type: none"> <li>■ ½" NPT (installation in the tank from outside)</li> <li>■ G ¼" (installation from inside, PP version)</li> <li>■ G ⅜" (installation from inside, stainless steel version)</li> </ul>
Pressure	<ul style="list-style-type: none"> <li>■ HLS-M1: 1 bar</li> <li>■ HLS-M2: 5 bar</li> </ul>
Temperature	<ul style="list-style-type: none"> <li>■ HLS-M1: -10 ... +80 °C</li> <li>■ HLS-M2: -40 ... +120 °C</li> </ul>
Material	<ul style="list-style-type: none"> <li>■ HLS-M1: PP</li> <li>■ HLS-M2: Stainless steel 1.4301</li> </ul>
Electrical connection	<ul style="list-style-type: none"> <li>■ HLS-M1: Cable</li> <li>■ HLS-M2: Cable or connector</li> </ul>
Data sheet	LM 30.06

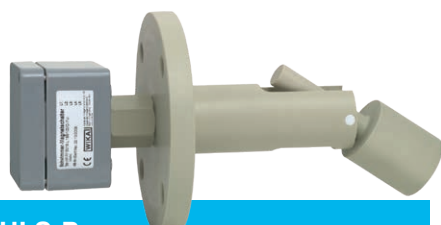
**HLS-P**

Plastic version, for horizontal installation

Process connection	Flange DIN, ANSI, EN
Pressure	0 ... 3 bar
Temperature	-10 ... +80 °C
Density	≥ 750 kg/m <sup>3</sup>
Material	PP
Data sheet	LM 30.02

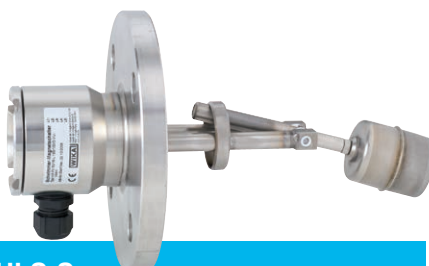
**HLS-S**Stainless steel version,  
for horizontal installation

Process connection	Flange DIN, ANSI, EN
Pressure	0 ... 232 bar
Temperature	-196 ... +350 °C
Density	≥ 600 kg/m <sup>3</sup>
Material	Stainless steel, titanium
Data sheet	LM 30.02

**HLS-SBI  
Ex i**Intrinsically safe stainless steel version  
for horizontal installation

Process connection	<ul style="list-style-type: none"> <li>■ Mounting flange: DIN DN 50 ... DN 100, PN 6 ... 160 EN 1092 DN 50 ... DN 100, PN 6 ... PN 160 ANSI 2" ... 4", class 150 ... 900</li> <li>■ Square flange: DN 80 and DN 92 (other flanges on request)</li> </ul>
Pressure	0 ... 100 bar (180 bar on request)
Temperature class	T2    T3    T4    T5    T6
Process tempera- ture	180 °C    160 °C    108 °C    80 °C    65 °C
Ambient tempera- ture at case	80 °C
Density	600 kg/m <sup>3</sup>
Material	Stainless steel 1.4571
Data sheet	LM 30.02

# Optoelectronic switches for the process industry

## Applications

- Chemical industry, petrochemical industry, natural gas, offshore
- Shipbuilding, machine building, refrigerator units
- Power generating equipment, power plants
- Process water and drinking water treatment
- Wastewater and environmental engineering

## Special features

- Temperature ranges from -269 ... +400 °C
- Versions for pressure ranges from vacuum to 500 bar
- Special versions: High pressure, interface measurement
- Signal processing is made using a separate model OSA-S switching amplifier



### OLS-S, OLS-H

Standard and high-pressure version

Material Stainless steel, Hastelloy, KM-glass, quartz glass, sapphire, graphite

Process connection ■ G 1/2 A  
■ 1/2 NPT

Pressure 0 ... 500 bar

Temperature -269 ... +400 °C

Data sheet LM 31.01

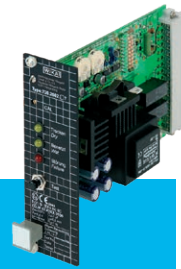

### OSA-S

Switching amplifier, for models OLS-S, OLS-H

Output 1 signal relay, 1 failure relay

Function High or low alarm

Time delay To 8 s

Voltage supply AC 24/115/120/230 V  
DC 24 V

Data sheet LM 31.01



### OLS-C20

Compact design, high-pressure version

Material Stainless steel, quartz glass

Process connection ■ M16 x 1.5  
■ G 1/2 A  
■ 1/2 NPT

Insertion length 24 mm

Pressure 0 ... 50 bar

Temperature -30 ... +135 °C

Data sheet LM 31.02

# Optoelectronic switches for industrial applications

## Applications

- Limit detection of liquids
- Machine tools
- Hydraulics
- Machine building
- Water technology

## Special features

- For liquids such as oils, water, distilled water, aqueous media
- Compact design
- Mounting position as required
- Accuracy  $\pm 2$  mm
- No moving components

**OLS-C01**  
Standard version

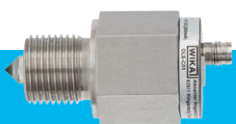

Material	Stainless steel, borosilicate glass
Process connection	G 3/8", G 1/2" or M12 x 1
Pressure	Max. 25 bar
Temperature	-30 ... +100 °C
Switching output	1 x PNP
Data sheet	LM 31.31

**OLS-C02**  
With selectable switch length



Material	Stainless steel, borosilicate glass
Process connection	G 1/2"
Pressure	Max. 25 bar
Temperature	-30 ... +100 °C
Switch length	65 ... 1,500 mm
Switching output	1 x PNP
Data sheet	LM 31.32

**OLS-C05**  
High-temperature version



Material	Stainless steel, borosilicate glass
Process connection	G 1/2"
Pressure	Max. 25 bar
Temperature	-40 ... +170 °C
Switching output	1 x PNP
Data sheet	LM 31.33

# Optoelectronic switches for industrial applications

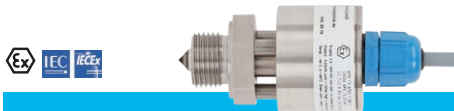

**OLS-C51**  
Intrinsic safety Ex i

Material	Stainless steel, borosilicate glass
Process connection	G 1/2"
Pressure	Max. 40 bar
Temperature	-30 ... +135 °C
Output signal	4 ... 20 mA low/high as switching output
Data sheet	LM 31.04



**OLS-C04**  
For refrigeration technology

Material	Steel, nickel-plated; melted glass
Process connection	G 1/2", 1/2" NPT
Pressure	Max. 40 bar
Temperature	-40 ... +100 °C
Switching output	1 x PNP
Data sheet	LM 31.34

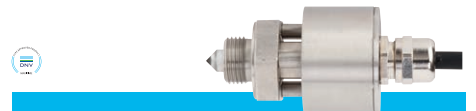

**OLS-5200**  
For the shipbuilding industry

Material	Stainless steel, borosilicate glass
Process connection	Male thread G 1/2" or M18 x 1.5
Pressure	Max. 25 bar
Temperature	-40 ... +130 °C
Switching output	1 x PNP
Vibration resistance	10 ... 5,000 Hz, 0 ... 60g
Data sheet	LM 31.06



# Vibrating level switches



**TLS-S**  
Ex version

Material (wetted)	<ul style="list-style-type: none"> <li>■ Stainless steel 1.4404 (316L)</li> <li>■ Stainless steel 1.4404, 1.4435 (316L), electropolished</li> <li>■ Stainless steel 1.4404 (316L) with PFA coating</li> <li>■ Stainless steel 1.4404 (316L) with ECTFE coating</li> <li>■ Hastelloy C-276</li> <li>■ Hastelloy C-276, electropolished</li> </ul>
-------------------	--

Process connection	<ul style="list-style-type: none"> <li>■ G 3/4" ... 2"</li> <li>■ 3/4" ... 2" NPT</li> <li>■ DN 25 ... DN 100 per DIN EN 1092-1</li> <li>■ 1" ... 4" per ASME B16.5 / ASME BPE</li> </ul>
--------------------	---

Pressure -1 ... +100 bar

Temperature -40 ... +200 °C

Density ≥ 500 ... 2,500 kg/m<sup>3</sup>

Output signal

- DPDT relay output
- PNP transistor output
- NAMUR (8.2 V)

Data sheet LM 30.10



**TLS-C**  
Compact version

Material (wetted)	<ul style="list-style-type: none"> <li>■ Stainless steel 1.4404 (316L)</li> <li>■ Stainless steel 1.4404, 1.4435 (316L), electropolished</li> <li>■ Hastelloy C-276</li> <li>■ Hastelloy C-276, electropolished</li> </ul>
-------------------	--

Process connection	<ul style="list-style-type: none"> <li>■ G 3/4" ... 2"</li> <li>■ 3/4" ... 2" NPT</li> <li>■ 1" ... 4" per ASME BPE</li> </ul>
--------------------	--

Pressure -1 ... +64 bar

Temperature -40 ... +150 °C

Density ≥ 500 ... 2,500 kg/m<sup>3</sup>

Output signal

- SPST relay output
- PNP transistor output

Data sheet LM 30.10



**TLS-H**  
Hygienic design version

Material (wetted)	<ul style="list-style-type: none"> <li>■ Stainless steel 1.4404 (316L)</li> <li>■ Stainless steel 1.4404, 1.4435 (316L), electropolished</li> <li>■ Hastelloy C-276</li> <li>■ Hastelloy C-276, electropolished</li> </ul>
-------------------	--

Process connection	<ul style="list-style-type: none"> <li>■ G 3/4" ... 2"</li> <li>■ 3/4" ... 2" NPT</li> <li>■ 1" ... 4" per ASME BPE</li> </ul>
--------------------	--

Pressure -1 ... +64 bar

Temperature -40 ... +150 °C

Density ≥ 500 ... 2,500 kg/m<sup>3</sup>

Output signal

- SPST relay output
- PNP transistor output

Data sheet LM 30.10

# Compression force transducers

Compression force transducers are designed for determining compression forces and are suitable for static and dynamic measurements in the direct force flow. WIKA force transducers are manufactured from stainless steel and other high-quality materials, are robust and are notable for their reliability and high quality even in complex applications. Our compression force transducers are available in different rated loads.

They cover a wide range of application areas: For instance, these

force transducers are employed in machine building or in the automation of plants to determine the pressing and joining forces, as well as for detecting weight in many industrial applications. You can select the pertinent technical and regional approvals as options.



**EAC** **LoRaWAN** 

**F1106, F1119, F1136**  
Hydraulic compression force transducer, clamping force test instrument up to 500 kN

Rated force $F_{nom}$	0 ... 160 N to 0 ... 500 kN
Relative linearity error	<ul style="list-style-type: none"> <li>■ Analogue <math>\leq \pm 1.6\% F_{nom}</math></li> <li>■ Digital <math>\leq \pm 0.5\% F_{nom}</math></li> </ul>
Display	<ul style="list-style-type: none"> <li>■ Analogue indication</li> <li>■ Digital display</li> <li>■ Pressure sensor</li> </ul>
Ingress protection	IP65, digital IP67
Data sheet	FO 52.13, FO 52.10, FO 52.27



**EAC** 

**F1102**  
Hydraulic compression force transducer, welding tongs test instrument up to 36 kN

Rated force $F_{nom}$	0 ... 100 N to 0 ... 36 kN
Relative linearity error	<ul style="list-style-type: none"> <li>■ Analogue <math>\leq \pm 1.6\% F_{nom}</math></li> <li>■ Digital <math>\leq \pm 0.5\% F_{nom}</math></li> </ul>
Display	<ul style="list-style-type: none"> <li>■ Analogue indication</li> <li>■ Digital display</li> <li>■ Pressure sensor</li> </ul>
Ingress protection	IP65, IP67
Data sheet	FO 52.16



**EAC** 

**F1103, F1112, F1122**  
Hydraulic compression force transducer, 3-jaw clamping force test instrument up to 1,000 kN

Rated force $F_{nom}$	0 ... 1.1 kN to 0 ... 1,000 kN
Relative linearity error	<ul style="list-style-type: none"> <li>■ Analogue <math>\leq \pm 1.6\% F_{nom}</math></li> <li>■ Digital <math>\leq \pm 0.5\% F_{nom}</math></li> </ul>
Display	<ul style="list-style-type: none"> <li>■ Analogue indication</li> <li>■ Digital display</li> <li>■ Pressure sensor</li> </ul>
Ingress protection	IP65, IP67
Data sheet	FO 52.24, FO 52.25, FO 52.26



**EAC** 

**F1201**  
Compression force transducer up to 36 kN

Rated load $F_{nom}$	0 ... 5 t to 0 ... 30 t
Relative linearity error	$\leq \pm 0.05\% F_{nom}$
Output signal	$2.0 \pm 0.2 \text{ mV/V}$
Ingress protection	IP68
Data sheet	FO 51.71



**EAC**

**F1222**  
Miniature compression force transducer from 10 N

Rated force $F_{nom}$	0 ... 10 N to 0 ... 5,000 N
Relative linearity error	$\pm 1\% F_{nom}$
Output signal	<ul style="list-style-type: none"> <li><math>\pm 0.1 \text{ mV/V}</math> (10 N)</li> <li><math>\pm 0.2 \text{ mV/V}</math> (20 N to 5 kN)</li> </ul>
Ingress protection	IP65
Data sheet	FO 51.11



**EAC** **LoRaWAN** 

**F1861**  
Compression force transducer with bilateral spherical force introduction up to 50 t

Rated load $F_{nom}$	0 ... 10 t to 0 ... 50 t
Relative linearity error	$\leq 0.03\% F_{nom}$
Output signal	$2.0 \pm 0.2 \text{ mV/V}$
Ingress protection	IP67
Data sheet	FO 51.61

# Tension/Compression force transducers

WIKA offers tension/compression force transducers in different designs and versions. They are available in miniature designs, as traditional s-type, as transducers with different thread forms or as low-profile force transducers. Transducers in miniature design are used for small mounting spaces and also for detecting small forces. The s-type with female thread, which is very well suited for this purpose, features a particularly high accuracy and is used

in rated load ranges of up to 50 kN. For measuring high forces, tension/compression force transducers in compact design are the first choice. For low-profile force transducers, the force is transmitted via the central female thread. They are highly dynamic and possess a high fatigue strength.



EAC

## F2220, F2221

Miniature tension/compression force transducer from 10 N

Rated force  $F_{nom}$  0 ... 10 N to 0 ... 50 kN

Relative linearity error from  $\pm 0.15\% F_{nom}$

Output signal 1.5  $\pm$  0.15 or 2.0  $\pm$  0.2 mV/V

Ingress protection IP65

Data sheet FO 51.16, FO 51.26



EAC

## F2222

Tension/Compression force transducer up to 2,200 kN

Rated force  $F_{nom}$  0 ... 22 N up to 0 ... 2,200 kN

Relative linearity error  $\pm 0.1\% F_{nom}$

Output signal ■  $\leq 25$  lb: 2 mV/V  
■  $> 50$  lb: 3 mV/V

Ingress protection IP66

Data sheet FO 51.29



EAC

## F2226

Tension/Compression force transducer, male thread up to 3,300 kN

Rated force  $F_{nom}$  0 ... 10 kN to 0 ... 3,300 kN

Relative linearity error ■  $\leq \pm 0.15\% F_{nom}$  ( $\leq 200$  kN)  
■  $\leq \pm 0.20\% F_{nom}$  ( $> 200$  kN)

Output signal 2 mV/V

Ingress protection IP66

Data sheet FO 51.51



EAC Ex IEC IECEx C RU US Ex

## F2301, F23C1, F23S1

Tension/Compression force transducer with thin-film technology up to 500 kN

Rated force  $F_{nom}$  0 ... 1 kN to 0 ... 500 kN

Relative linearity error  $\pm 0.5\% F_{nom}$

Output signal ■ 4 ... 20 mA, 2-wire/3-wire  
■ 0 ... 10 V, 3-wire  
■ CANopen®  
■ Redundant versions available

Ingress protection IP66, IP67, IP68, IP69, IP69K

Data sheet FO 51.17



EAC LoRaWAN Bluetooth

## F2802

Tension/Compression force transducer, S-type up to 50 kN

Rated force  $F_{nom}$  0 ... 0.5 kN to 0 ... 50 kN

Relative linearity error  $d_{lin}$  ■ Steel  $\pm 0.03\% F_{nom}$   
■ Stainless steel  $\pm 0.05\% F_{nom}$

Output signal 2.0  $\pm$  5 % mV/V

Ingress protection IP65 ( $< 5$  kN), IP67 ( $\geq 5$  kN)

Data sheet FO 51.48



EAC LoRaWAN Bluetooth

## F2808

Tension/Compression force transducer from 5 N

Rated force  $F_{nom}$  0 ... 5 N to 0 ... 2,000 N

Relative linearity error  $\pm 0.15\% F_{nom}$

Output signal 2.0  $\pm$  10 % mV/V

Ingress protection IP66

Data sheet FO 51.68

# Bending/Shear beams

Bending beams and shear beams are used for the determination of (shear) forces and are suitable for both static (weighing technology) and dynamic (machine building) measurement projects. To determine how strong the force is in the application, strain gauges or thin-film sensors are used, which are attached on or in the measuring body.

The application areas of the bending beam and shear beam are many and varied. Thus, these load cells are very often used in industrial weighing technology as well as in the areas of special machine building, manufacturing automation and gravimetric level measurement. In addition, they are used in the laboratory and process industry for the indirect determination of torques.



**F3201,  
F3831**  
Shear beam up to 10 t

Rated load $F_{nom}$	0 ... 500 kg to 0 ... 10,000 kg
Relative linearity error	From $\pm 0.017\%$ $F_{nom}$
Output signal	2.0 $\pm$ 0.2 mV/V
Ingress protection	IP65, IP67, IP68, IP69K, depending on version
Data sheet	FO 51.21, FO 51.72



**F3203,  
F3833**  
Bending beam up to 500 kg

Rated load $F_{nom}$	0 ... 5 kg to 0 ... 500 kg
Relative linearity error	From $\pm 0.017\%$ $F_{nom}$
Output signal	2.0 $\pm$ 0.2 mV/V
Ingress protection	IP68, IP69, depending on version
Data sheet	FO 51.22, FO 51.73

**AZK02**  
Mounting kit  
for shear beams F3201 and F3831



Data sheet FO 51.21

**AZK03**  
Mounting kit for bending beams  
F3203 and F3833



Data sheet FO 51.22

# Load cells

Load cells are designed as a special form of force transducers for use in weighing equipment. They enable very high measurement accuracies between 0.01 % and 0.05 %  $F_{nom}$ .

Typical and widely used load cell geometries are single point load

cells, bending and shear beam load cells, s-type load cells, pendulum load cells and compression force load cells. In addition, there are corresponding mounting kits and complete weighing modules available.



**F4801**  
Single point load cell  
up to 250 kg

Rated load  $F_{nom}$  0 ... 3 to 0 ... 250 kg

Relative linearity error 0.02 %  $F_{nom}$

Output signal 2.0 ± 10 % mV/V

Ingress protection IP65

Data sheet FO 53.10



**F4802**  
Single point load cell  
up to 10 kg

Rated load  $F_{nom}$  0 ... 0.3 kg to 0 ... 10 kg

Relative linearity error 0.02 %  $F_{nom}$

Output signal ■ 1.0 ± 10 % mV/V (0.3 ... 0.5 kg)  
■ 2.0 ± 10 % mV/V (1 ... 10 kg)

Ingress protection IP65

Data sheet FO 53.13



**F4818**  
Single point load cell  
up to 500 kg

Rated load  $F_{nom}$  0 ... 20 kg to 0 ... 500 kg

Relative linearity error 0.02 %  $F_{nom}$

Output signal 2.0 ± 10 % mV/V

Ingress protection IP65

Data sheet FO 53.14



**F4881**  
Load cell  
for multihead weighers

Rated load  $F_{nom}$  0 ... 2 kg to 0 ... 30 kg

Relative linearity error 0.02 %  $F_{nom}$

Output signal 2.0 ± 0.2 mV/V

Ingress protection IP67

Data sheet FO 53.16



**F4882, F4883,  
F4884, F4885**  
Load cells for checkweighers

Rated load  $F_{nom}$  0 ... 1 kg to 0 ... 635 kg

Relative linearity error ≤ 0.02 %  $F_{nom}$

Output signal 2.0 ± 0.2 mV/V

Ingress protection IP66 or IP67

Data sheet FO 53.17, FO 53.18, FO 53.19, FO 53.20

# Load pins

Load pins represent one of the most important components for measuring forces. Existing retention bolts can easily be replaced by these products in existing applications. The application areas range from construction machinery and cranes to manufacturing automation. These force transducers are often used by designers because, due to their design, they can be directly integrated into the force flow, without taking up space.

individual, the exact layout is important. With WIKA, you will have specialists by your side who already have lots of experience in force measurement.

Since the design requirements for the use of load pins are very

**ERC Ex IEC IECEx Ex c RU us**



**F5308, F53C8, F53S8**

Load pin, heavy-duty version, thin-film technology from 10 kN

Rated force $F_{nom}$	From 10 kN
Relative linearity error	$\pm 1 \% F_{nom} / \pm 1.5 \% F_{nom}$
Output signal	<ul style="list-style-type: none"> <li>■ 4 ... 20 mA, 2-wire/3-wire</li> <li>■ 0 ... 10 V, 3-wire</li> <li>■ CANopen® redundant versions available</li> </ul>
Ingress protection	<ul style="list-style-type: none"> <li>■ Unplugged state IP66, IP67</li> <li>■ Plugged-in state IP68, IP69, IP69K</li> </ul>
Data sheet	FO 51.43

**ERC Ex IEC IECEx Ex c RU us**



**F5301, F53C1**

Load pin with thin-film technology up to 200 kN

Rated force $F_{nom}$	0 ... 5 kN to 0 ... 200 kN
Relative linearity error	$\pm 1 \% F_{nom}$
Output signal	<ul style="list-style-type: none"> <li>■ 4 ... 20 mA, 2-wire/3-wire</li> <li>■ 0 ... 10 V, 3-wire</li> <li>■ CANopen® redundant versions available</li> </ul>
Ingress protection	<ul style="list-style-type: none"> <li>■ Unplugged state IP66, IP67</li> <li>■ Plugged-in state IP68, IP69, IP69K</li> </ul>
Data sheet	FO 51.18

**ERC Ex**



**F5802**

Load pin from 20 kN

Rated force $F_{nom}$	20 ... 10,000 kN
Relative linearity error	0.5 % ... 1 % $F_{nom}$
Output signal	<ul style="list-style-type: none"> <li>■ 4 ... 20 mA, 2-wire/3-wire</li> <li>■ 0 ... 10 V, 3-wire</li> <li>■ CANopen® redundant versions available</li> </ul>
Ingress protection	<ul style="list-style-type: none"> <li>■ Unplugged state IP66, IP67</li> <li>■ Plugged-in state IP68, IP69, IP69K</li> </ul>
Data sheet	FO 51.55

# Tension links

Large lifting equipment and cranes generally move high to very high loads. In (container) ports, in offshore applications or on construction sites, (failure) safety in the movement of goods and loads is important. Man and machine must be protected equally and a smooth process must be ensured. Among other things, when moving loads, tension links, which are placed directly in the force flow, ensure safe operation in order to prevent overloading of the machinery. These force transducers are available in very small dimensions up to very large formats. Tension links from WIKA with proven thin-film technology guarantee maximum safety in their application thanks to their first-rate quality.

**ERC**



**F7301, F73C1, F73S1**

Tension link with thin-film technology from 5 kN

Rated force $F_{nom}$	From 0 ... 5 kN
Relative linearity error	$\pm 0.5 \% F_{nom}$
Output signal	<ul style="list-style-type: none"> <li>■ 4 ... 20 mA, 2-wire/3-wire</li> <li>■ 0 ... 10 V, 3-wire</li> <li>■ CANopen® redundant versions available</li> </ul>
Ingress protection	<ul style="list-style-type: none"> <li>■ Unplugged state IP66, IP67</li> <li>■ Plugged-in state IP68, IP69, IP69K</li> </ul>
Data sheet	FO 51.19

# Ring force transducers

These force transducers are extremely robust and are suitable for the detection of very high (static) forces. Furthermore, they are suitable for many installation situations. The ring geometry is used in force measurement for a wide variety of spatial conditions. The main fields of application are found in spindle presses, in screw force measurement or even in geotechnology.

WIKA offers electrical and hydraulic ring force transducers in diameters from 12 millimetres up to 430 millimetres as well as in various installation heights.

Discover our portfolio now.

ERC

F6212



Ring force transducer  
up to 100 kN

Rated force $F_{nom}$	0 ... 2 to 0 ... 100 kN
Relative linearity error	$\leq 0.5 \% F_{nom}$
Output signal	0.8 ... 1.2 $\pm 0.1$ mV/V
Ingress protection	IP65
Data sheet	FO 51.27

ERC

F6215

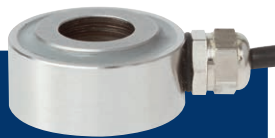

Ring force transducer  
up to 1,500 kN

Rated force $F_{nom}$	0 ... 15 to 0 ... 1,500 kN
Relative linearity error	$\leq \pm 1 \% F_{nom}$
Output signal	0.8 ... 1.2 $\pm 0.1$ mV/V
Ingress protection	IP65
Data sheet	FO 51.28

ERC LoRaWAN



F6116



Hydraulic ring force transducer  
up to 120 kN

Rated force $F_{nom}$	0 ... 320 N to 0 ... 120 kN
Relative linearity error	Analogue $\leq \pm 1.6 \% F_{nom}$ Digital $\leq \pm 0.5 \% F_{nom}$
Display	<input type="checkbox"/> Analogue indication <input type="checkbox"/> Digital display <input type="checkbox"/> Pressure sensor
Ingress protection	IP65, IP67
Data sheet	FO 52.18

ERC LoRaWAN



F6154



Hydraulic ring force transducer,  
heavy-duty version up to 1,500 kN

Rated force $F_{nom}$	0 ... 25 kN to 0 ... 1,500 kN
Relative linearity error	Analogue $\leq \pm 1.0 \% F_{nom}$ Digital $\leq \pm 0.5 \% F_{nom}$
Display	<input type="checkbox"/> Analogue indication <input type="checkbox"/> Digital display <input type="checkbox"/> Pressure sensor
Ingress protection	IP65, IP67
Data sheet	FO 52.17

# Special force transducers

We refer to force transducers that do not fit into any standard design as special force transducers. Due to the specification of the requirement, in some cases design-engineered solutions must be considered. As a long-standing manufacturer of force measurement technology, WIKA brings this expertise into play and can find the best and, at the same time, most cost-effective solution for the customer. Among our special force transducers

are, for example, strain transducers that enable components to measure or force transducers for checking rope tension (wire rope force transducers). The applications in which special force transducers are used are wide-ranging and always require great experience in their engineering. You can count on this when you trust in the right solution from WIKA.



**F9204**  
Wire rope force transducer up to 40 t

Rated load $F_{nom}$	0 ... 1 to 0 ... 40 t
Relative linearity error	$\pm 3\% F_{nom}$
Output signal	4 ... 20 mA, 2-wire
Ingress protection	IP66
Data sheet	FO 51.25



**F9302**  
Strain transducer up to 1,000  $\mu\epsilon$

Strain $F_{nom}$	0 ... $\pm 200$ , 0 ... $\pm 500$ , 0 ... $\pm 1,000 \mu\epsilon$
Relative linearity error	$\leq \pm 2\% F_{nom}$
Output signal	4 ... 20 mA, 3-wire
Ingress protection	IP67
Data sheet	FO 54.10



**FRKPS**  
Chain hoist test set for checking friction clutches

Rated force $F_{nom}$	40 ... 3,500 kg
Relative linearity error	0.5 % $F_{nom}$
Output signal	4 ... 20 mA
Ingress protection	■ Force transducer IP67 ■ Display instrument IP40
Data sheet	FO 51.69

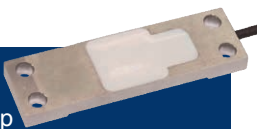

**F9846**  
Strain transducer up to 1,000  $\mu\epsilon$

Nominal strain $F_{nom}$	0 ... 200 $\mu\epsilon$ to max. 0 ... 1,000 $\mu\epsilon$
Relative linearity error	$\pm 1\% F_{nom}$
Output signal	1.0 $\pm 0.1$ mV/V
Ingress protection	IP65
Data sheet	FO 54.17



# Electronics

Many force measurement applications can be complemented by electronic components. To ensure that all system-relevant components come from a single source, WIKA continuously expands its product range with useful electronics. WIKA offers controllers, amplifiers, limit switches, hand-held measuring instruments, digital displays and electronic accessories that ensure trouble-free

operation. With the help of electronics matched to the measuring components, set limit values are maintained and checked with the reading instruments. Amplifiers are available with analogue and digital output signals. The LED or LC displays are available with 4 or 6 digits.



## B1940

Analogue cable amplifier for strain gauge measuring bridges

Input Strain gauge measuring bridge, 4- or 6-wire

Output 0/4 ... 20 mA, DC 0 ... 10 V

Special feature

- High accuracy
- Cable length between amplifier and read-out unit: to 100 m are possible
- Compact design
- Ingress protection IP67

Auxiliary power DC 12 ... 28 V

Data sheet AC 50.09



## ELMS1

Safety electronics PLe in accordance with DIN EN ISO 13849-1

Input

- 8 safe 4 ... 20 mA analogue inputs
- 8 safe digital inputs
- Fieldbus

Output

- 2 safe relay outputs
- 6 safe, positive-switching solid-state outputs
- Fieldbus

Special feature

- Certified safety electronics, certified in accordance with DIN EN ISO 13849-1, PLe
- Certified system solution incl. force measurement, certified in accordance with DIN EN 13849-1 cat. 3, PLd

Auxiliary power DC 24 V

Data sheet AC 50.06



## EGS80

Digital limit switch

Input

- 0/4 ... 20 mA

Output

- Two potential-free relay contacts (change-over) with status LED
- One freely programmable analogue output (0 ... 20 mA)

Special feature

- Galvanic isolation, line break (LB) and short-circuit (SC) monitoring to SIL 2 per IEC 61508

Auxiliary power

- DC 20 ... 90 V
- AC 48 ... 253 V

Data sheet AC 50.01



## E1930, E1931, E1932

Multi-function display for industrial mV/V and analogue measuring instruments

5/6-digit digital display with high accuracy

Ingress protection IP65

Data sheet FO 58.05, FO 58.06, FO 58.07



## FE430

Weighing indicator

Accuracy class in accordance with OIML with EU type approval 6000e

Ingress protection IP65

Data sheet AC 50.14



## B6578

Junction box for load cells

Number of load cells Max. 4

Ingress protection IP67

Data sheet FO 58.02



# Orifice plates and assemblies

Orifice plates represent the most common primary flow elements in the world due to their proven technology and ease of installation and maintenance.

## Main characteristics

- Maximum operating temperature to 800 °C
- Maximum operating pressure to 400 bar
- Suitable for liquid, gas and steam flow measurement
- Accuracy: Uncalibrated  $\pm 0.5 \dots 2.5 \%$
- Repeatability of measurement 0.1 %



**FLC-OP**  
Orifice plate

Standards ■ ISO 5167-2  
■ ASME MFC3M

Pipe size ■  $\geq 2"$   
■  $\geq 50$  mm

$\beta$  Depending on version

Accuracy <sup>1)</sup> Uncalibrated  $\pm 0.5 \dots 2.5 \%$

Data sheet FL 10.01

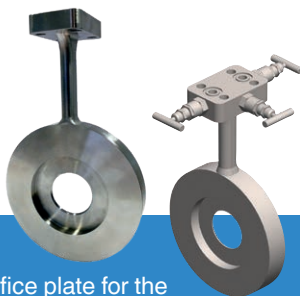

**FLC-CO**  
Compact orifice plate for the direct mounting of differential pressure transmitters

Standards ■ ISO 5167-2  
■ ANSI/ASME B16.5

Pipe size ■ 2 ... 14"  
■ DN 50 ... 350

$\beta$  Depending on version

Accuracy  $\leq \pm 0.5 \%$

Data sheet FL 10.10

## Versions

- **Square edge orifice plates** (standard version) This design is intended for general applications in clean liquids and gases.

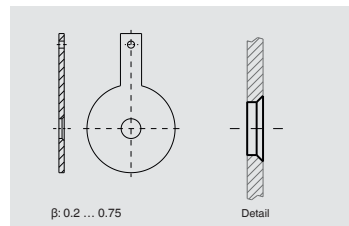

- **Quarter circle and conical entrance orifice plates**

The best choice for measurement of liquids with low Reynolds number.

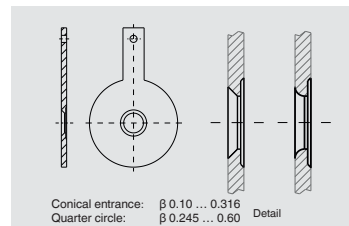

- **Segmental orifice plates**

For measurements with two-phase, dirty and solids-containing media.

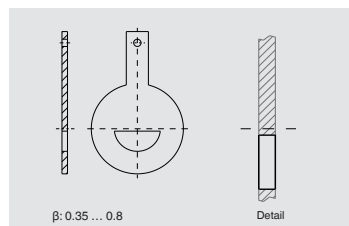

- **Eccentric orifice plates**

The application areas are similar to the segmental version. However, an eccentric orifice plate is the better solution for smaller pipe diameters.

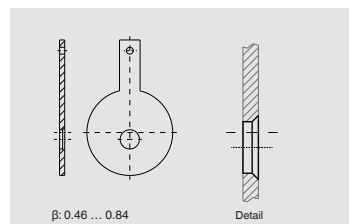

Orifice flanges are intended for use instead of standard pipe flanges when an orifice plate or flow nozzle must be installed. Pairs of pressure tapings are machined into the orifice flange, making separate orifice carriers or tapings in the pipe wall unnecessary.

#### Main characteristics

- Wide range of materials available
- The number and type of pressure tapping (flange tap or corner tap) can be manufactured to customer requirements
- Special assemblies can be designed on request



#### FLC-FL Orifice flange

Standards

- ISO 5167-2
- ASME B16.36

Pipe size

- $\geq 2''$
- $\geq 50$  mm

$\beta$  Depending on version

Accuracy <sup>1)</sup> Uncalibrated  $\pm 0.5 \dots 2.5$  %

Data sheet FL 10.12



#### FLC-MP Multi-hole orifice plate

Standards

- ISO 5167-2
- AGA Report number 3
- ASME B16.36

Pipe size

- 50 ... 600 mm [2" ... 24"]
- Larger versions on request

$\beta$  0.2 ... 0.65

Accuracy <sup>1)</sup> 1 ... 2 % depending on beta ratio and Reynolds number

Data sheet FL 10.15

Annular chambers are designed to be mounted between standard pipe flanges. Versions are available to suit all common flange standards, including DIN and ANSI B16.5.

#### Main characteristics

- Standard material is 316/316L stainless steel, but a wide range of alternative materials is available
- Seals are included in the scope of delivery (as standard, 4.4 mm thick spiral-wound sealing 316/graphite filler, unless requested otherwise)



#### FLC-AC Annular chamber

Standards ISO 5167-2

Pipe size

- $\geq 2''$
- $\geq 50$  mm

$\beta$  Depending on version

Accuracy <sup>1)</sup> Uncalibrated  $\pm 0.5 \dots 2.5$  %

Data sheet FL 10.13

# Meter runs

To ensure high accuracy in the flow measurement of liquids, gases and steam the primary flow element is supplied as an assembly incorporating the upstream and downstream pipe sections required by ISO 5167-1:2003. This assembly is known as a "meter run".

### Main characteristics

- Nominal width < 1 ½"
- Nominal pressure rating 300 ... 2,500 depending on model/version
- Wide range of materials available

A calibration of the instrument can be performed if higher accuracy is required.

An integral orifice plate is normally selected when the pipe diameter is 1 ½" or smaller and the medium is clean. An extremely compact installation can be ensured as the pressure sensor can be mounted directly onto the meter run. Without a calibration, an accuracy of ±1 ... 2 % can be expected, the actual values will be confirmed during the engineering phase.

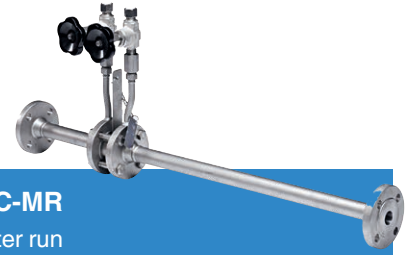

**FLC-MR**  
Meter run

Standards	ISO 5167-2
Pipe size	<ul style="list-style-type: none"> <li>■ ½ ... 1½ in</li> <li>■ 12 ... 40 mm</li> </ul>
$\beta$	0.2 ... 0.75
Accuracy	Uncalibrated ±1 ... 2 %
Data sheet	FL 10.02

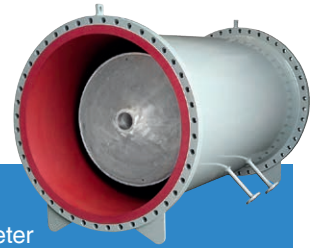

**FLC-FC**  
Cone flow meter

Standards	ISO 5167-5
Pipe size	2 ... 64"
$\beta$ and pipe length	0.45/0.6/0.75
Special feature	Low requirements for straight upstream and downstream pipes
Data sheet	FL 10.11

# Special assemblies



**FLC-HHR-PP**  
HHR ProPak™ flow meter  
for oil and gas

Pipe size	2", 3", 4", 6" or 8"
$\beta$ and pipe length	0.75 or 0.40
Special feature	No need for straight upstream and downstream pipes
Data sheet	FL 10.07

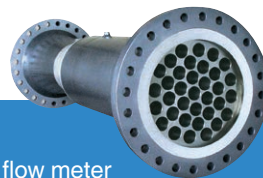

**FLC-HHR-FP**  
HHR FlowPak® flow meter

Pipe size	3 ... 48"
$\beta$ and pipe length	0.40 ... 0.70
Special feature	No need for straight upstream and downstream pipes
Data sheet	FL 10.09



**FLC-WG**  
Wedge flow meter for slurries and highly viscous media

Standards	ISO 5167-6
Pipe size	1 ... 24"
H/D ratios	0.2/0.3/0.4/0.5
Special feature	<ul style="list-style-type: none"> <li>■ Low maintenance through robust design</li> <li>■ For very high and very low Reynolds numbers</li> <li>■ Bidirectional measurement possible</li> </ul>
Data sheet	FL 10.08

# Flow nozzles

A flow nozzle consists of a convergent section with a rounded profile and a cylindrical throat. This design is generally selected for steam flow measurement at high velocity.

To reduce pressure loss an axisymmetric solution, called a Venturi nozzle, can be offered. It combines the standard features of a flow nozzle with a divergent section.

## Main characteristics

- Suitable for liquid, gas and steam flow measurement
- Optimum solution for measuring the flow of steam
- Accuracy: Uncalibrated  $\pm 0.8 \dots 2 \%$
- Repeatability of measurement 0.1 %
- Lower pressure loss compared to orifice plate family.

Flow nozzle for in-pipe installation

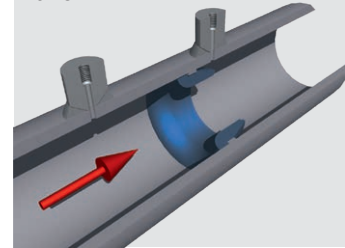

Venturi nozzle

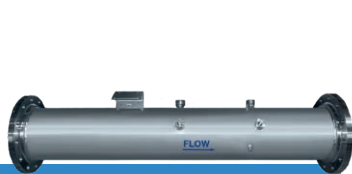
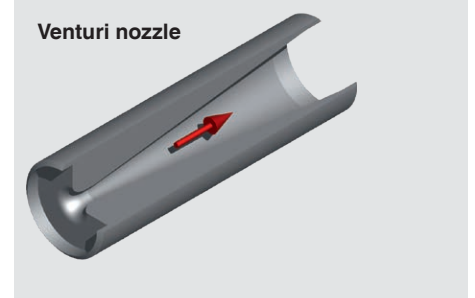

**FLC-FN-PIP**

Flow nozzle for in-pipe installation

Pipe size  
 ■  $\geq 2$  in  
 ■  $\geq 50$  mm

$\beta$  0.2 ... 0.8

Accuracy <sup>1)</sup> Uncalibrated  $\leq \pm 1 \%$

Data sheet FL 10.03



**FLC-FN-FLN**

Flow nozzle for flange assembly

Pipe size  
 ■  $\geq 2$  in  
 ■  $\geq 50$  mm

$\beta$  0.3 ... 0.8

Accuracy <sup>1)</sup> Uncalibrated  $\pm 0.8 \%$

Data sheet FL 10.03



**FLC-VN**

Venturi nozzle

Pipe size  
 ■  $\geq 2$  in  
 ■  $\geq 50$  mm

$\beta$  0.316 ... 0.775

Accuracy <sup>1)</sup> Uncalibrated  $\pm 1 \%$

Data sheet FL 10.03

# Venturi tubes

A Venturi tube is a reliable and easily managed and maintained instrument that can measure a wide range of clean liquids and gases.

The main advantage of a Venturi tube over other differential pressure flow measuring instruments is the higher pressure recovery and the lower upstream and downstream straight tube length requirements.

### Main characteristics

- In accordance with ISO 5167-4 and ASME MFC-3M standards
- Fabricated from plate or machined from bar/forgings
- Flanged or weld-in construction
- Wide range of materials available
- Pipe sizes from 50 ... 1,200 mm
- Wide variety of pressure tapings available
- Calibration possible on request
- Accuracy: Uncalibrated  $\pm 0.5 \dots 1.5 \%$

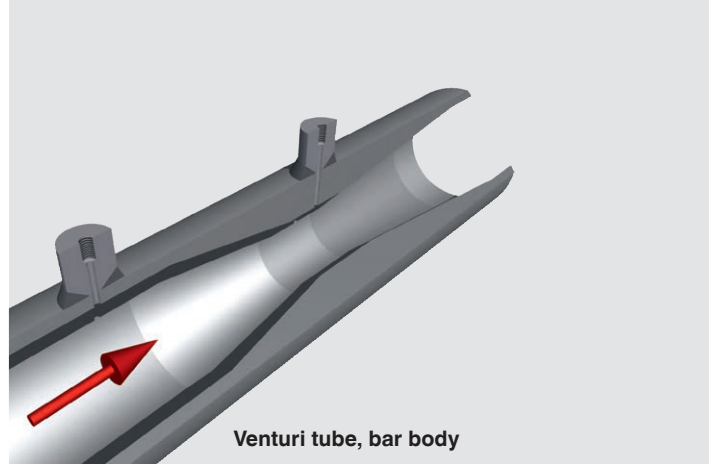

**FLC-VT-BAR**  
Venturi tube, bar body

Pipe size	<ul style="list-style-type: none"> <li>■ 2 ... 10 in</li> <li>■ 50 ... 250 mm</li> </ul>
$\beta$	0.4 ... 0.75
Accuracy <sup>1)</sup>	Uncalibrated $\leq \pm 0.5 \%$
Data sheet	FL 10.04



**FLC-VT-WS**  
Venturi tube, welded sheet

Pipe size	<ul style="list-style-type: none"> <li>■ <math>\geq 14</math> in</li> <li>■ 200 ... 1,200 mm</li> </ul>
$\beta$	0.4 ... 0.7
Accuracy <sup>1)</sup>	Uncalibrated $\pm 1.5 \%$
Data sheet	FL 10.04

# FloTec (averaging pitot tubes)

FloTec (a multi-port, averaging pitot tube) measures the difference between the static pressure and the dynamic pressure of the media in the pipe. The volumetric flow is calculated from that difference using Bernoulli's principle and taking into account the pipe inner diameter. Using four dynamic ports this instrument is able to evaluate a better velocity profile inside the pipe. This ensures a higher accuracy in the flow measurement.

## Main characteristics

- Low installation costs
- Long-term accuracy
- Minimal permanent pressure loss
- Fixed and extractable versions available

## Vortex shedding frequency

Depending on the inner diameter, the medium characteristics and the Reynolds number, a vortex will be generated around the pitot tube. A support mounted on the opposite side of the pipe can be supplied should the natural frequency of the pitot coincide with the vortex shedding frequency. The necessity test is performed during the design phase.

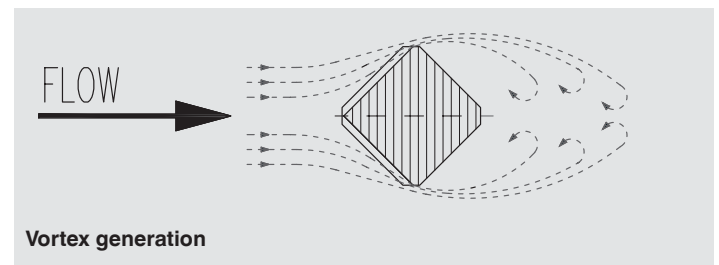

### FLC-APT-E FloTec, extractable

Pipe size ■  $\geq 3$  in  
■  $\geq 50 \dots 1,800$  mm

Accuracy Uncalibrated  $\pm 1$  %

Data sheet FL 10.05



### FLC-APT-F FloTec, fixed

Pipe size ■  $\geq 3$  in  
■  $\geq 50 \dots 1,800$  mm

Accuracy Uncalibrated  $\pm 1$  %

Data sheet FL 10.05

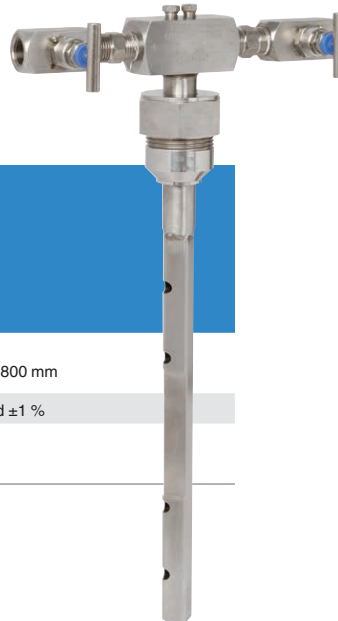

# Restriction orifices

When a reduction of pressure or a limitation of the flow rate is required, a restriction orifice must be inserted into the pipeline. Our technical department will produce the correct design for the restriction orifice, depending on customer requirements and flow conditions.

If a high pressure drop is required, phase changes or sound problems can occur, so that a more complex design might be needed. The solution in these cases is to decrease the differential pressure in several steps, avoiding all the issues created by these factors. This solution is called multi-step restriction orifice.

### Main characteristics

- Multi-step restriction orifices to reduce cavitation or undesired choking of the flow
- Multi-hole designs to reduce the noise level



**FLC-RO-ST**  
Single-step restriction orifice

Nominal size	½ ... 24"
Special feature	<ul style="list-style-type: none"> <li>■ Suitable for liquids, gases and steam</li> <li>■ Single-bore or multi-hole versions</li> </ul>
Data sheet	FL 10.06



**FLC-RO-MS**  
Multi-step restriction orifice

Nominal size	½ ... 24"
Special feature	<ul style="list-style-type: none"> <li>■ Suitable for liquids, gases and steam</li> <li>■ Special design with variable sections, with extension for high pressure drop requirements in gas applications</li> </ul>
Data sheet	FL 10.06

# Ultrasonic flow meter

### For custody transfer of gases

By calculating velocity ratios between two or more ultrasonic paths, the model FLC-UFL provides reliable gas flow measurement. Additional measured variables, such as sound velocity, signal-to-noise ratio or signal strength, are available for condition monitoring. For applications requiring integrated volume conversion, pressure and temperature sensors can be connected.

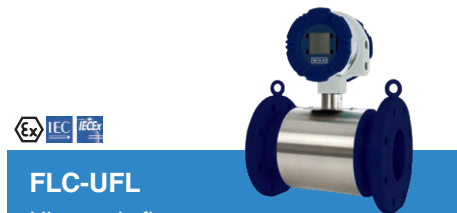

**FLC-UFL**  
Ultrasonic flow meter

Pressure range	To 153 bar [2,250 psi]
Accuracy	<p>FLC-UFL 1:</p> <ul style="list-style-type: none"> <li>■ 2 % (&gt; 3 m/s)</li> <li>■ 3 % (0.1 ... 3 m/s)</li> </ul> <p>FLC-UFL 2:</p> <ul style="list-style-type: none"> <li>■ 1.5 % (&gt; 3 m/s)</li> <li>■ 2 % (0.1 ... 3 m/s)</li> </ul> <p>FLC-UFL 3</p> <ul style="list-style-type: none"> <li>■ 1 % (Qt – Qmax)</li> <li>■ 2 % (Qmin – Qt)</li> </ul> <p>FLC-UFL 4</p> <ul style="list-style-type: none"> <li>■ 0.5 % (Qt – Qmax)</li> <li>■ 1 % (Qmin – Qt)</li> </ul>
Data sheet	FL 40.01



# Flow switches

## For monitoring liquid media



**FSD-4**  
For liquid media

Measuring range	<ul style="list-style-type: none"> <li>Flow: 0 ... 3 m/s</li> <li>Temperature: -20 ... 85 °C</li> </ul>
Output signal	<ul style="list-style-type: none"> <li>1 or 2 switching outputs plus optional analogue output</li> <li>Switching outputs PNP or NPN adjustable</li> <li>Analogue output 4 ... 20 mA or 0 ... 10 V adjustable</li> <li>Optional IO-Link</li> </ul>
Process connection	<ul style="list-style-type: none"> <li>G ¼ A, G ½ A</li> <li>¼ NPT, ½ NPT</li> <li>M18 x 1.5</li> <li>Various compression fittings optional</li> </ul>
Data sheet	FL 80.02



**FSM-6100**  
For industrial heat exchangers

Measuring range	<ul style="list-style-type: none"> <li>Max. operating flow: 150 ... 3,200 l/min</li> <li>Medium temperature: -20 ... +100 °C</li> </ul>
Output signal	<ul style="list-style-type: none"> <li>2 switch points</li> <li>Switch point repeatability: ±5 % of span</li> </ul>
Process connection	<ul style="list-style-type: none"> <li>1" NPT male per ASME B1.20.1</li> <li>1" BSPT male per ISO 7</li> </ul>
Data sheet	FL 60.01



**FSFD**  
Flow switch for wet sprinkler systems



Flow rate / Sensitivity	4 ... 10 GPM [15 ... 38 LPM]
Switching function	2 x SPDT (single pole double throw), form C
Data sheet	FL 50.01

# Electromagnetic flow meters



**FLC-608**  
Hybrid signal converter  
for electromagnetic flow meters

Special feature	<ul style="list-style-type: none"> <li>Available in different versions of installation and power supply</li> <li>HART® protocol and module for pressure and temperature readout available</li> </ul>
Standards	<ul style="list-style-type: none"> <li>EMC directive</li> <li>EN 61326 emission (group 1, class B) and immunity (industrial application)</li> </ul>
Data sheet	FL 20.05



**FLC-2200EL**  
For water-cycle and  
process applications



DN	<ul style="list-style-type: none"> <li>15 ... 2,000 mm</li> <li>0.5 ... 80 in</li> </ul>
Flow tube lining material	<ul style="list-style-type: none"> <li>PTFE – standard for pipe diameters DN 15 ... DN 100, on request also for DN &gt; 100</li> <li>Hard rubber (ebonite) – for diameter ≥ DN 125</li> </ul>
Standards	<ul style="list-style-type: none"> <li>ATEX (option for separated version)</li> <li>IECEx (option for separated version)</li> <li>MID MI-001 and OIML R49 for custody transfer</li> </ul>
Data sheet	FL 20.01



**FLC-1222**  
Retractable electromagnetic insertion  
sensor



DN	<ul style="list-style-type: none"> <li>50 ... 2,600 mm</li> <li>2 ... 104 in</li> </ul>
Special feature	<ul style="list-style-type: none"> <li>"Hot-tapping" installation possible (drilling of pipelines under pressure)</li> <li>Pressure gauge connection available</li> <li>1" GAS or 1" NPT stopcock</li> <li>No moving parts and no pressure loss</li> </ul>
Standards	<ul style="list-style-type: none"> <li>ATEX (option for separated version)</li> <li>IECEx (option for separated version)</li> </ul>
Data sheet	FL 20.07

# New opportunities for growth through holistic IIoT solutions

## From measured value to added value

With our innovative complete solutions, we support our customers to become future-proof by offering new added value through the combination and use of digital measured data across the entire value chain.



## Real-time monitoring

Predictive algorithms identify potential problems in advance, keep your employees up-to-date and trigger alarms in the event of critical values. This enables automatic or manual interventions to avoid production downtime.



## Team productivity

IIoT solutions from WIKA enable the automation of menial, time-consuming tasks to improve the efficiency of your employees. This minimises errors or failures that can arise from human error in repetitive, monotonous tasks.



## Data security

WIKa attaches great importance to the protection of your data. With complete end-to-end encryption, bidirectional communication and a cloud solution hosted in the EU, we consistently implement the highest security standards.



## Diagnostics and documentation

All measured data is archived to comply with internal and legal requirements. The seamless collection of data allows existing process weaknesses to be identified and eliminated with the help of diagnostic algorithms.



## Automation of maintenance

Maintenance actions are initiated automatically, eliminating the need for manual reading and estimating. This allows your team to focus on priority tasks.



## Cost reduction

Thanks to a precise, automatic evaluation of the measured data collected, all processes along your value chain can be optimised and unnecessary cost drivers eliminated.

### Sensors

- Radio units for measuring instruments
- Measuring instruments with IloT radio unit
- Mobile device app “myWIKa wireless device”

### Connectivity

LoRa, mioty, LTE/NB-IoT and 5G networks

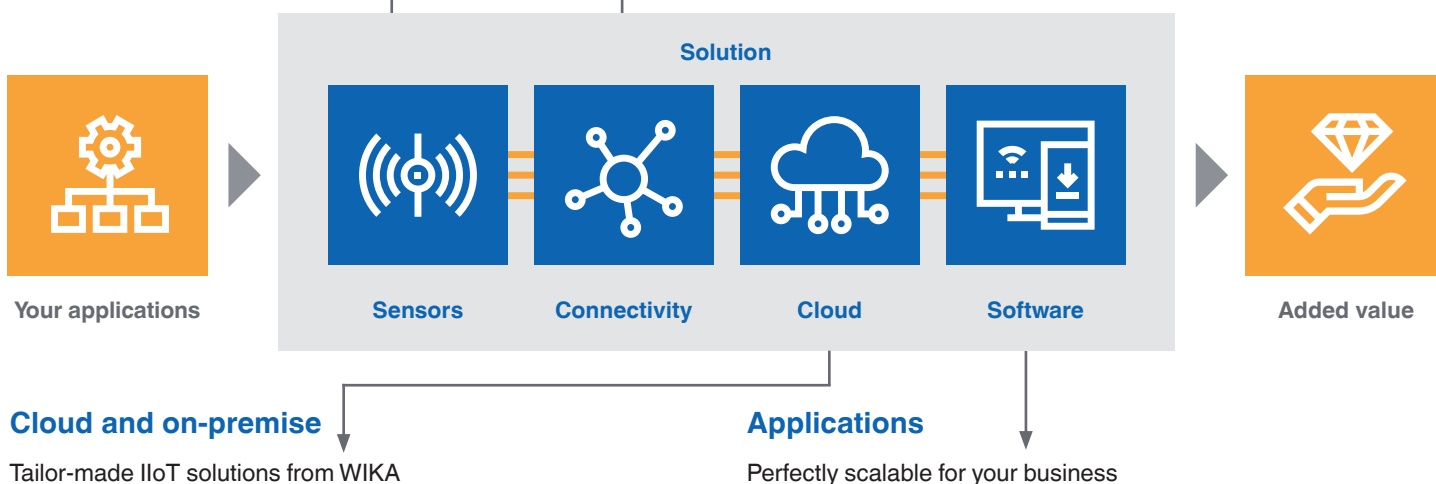

### Strong partner in IloT ecosystems

WIKa is a founding member of the mioty alliance, and not only drives the development of pioneering technologies, but also supports industrial standards such as LoRaWAN® and OPC UA. For WIKa, technological leadership has been the key to opening up new markets and applications for over 75 years.

cloud solutions are hosted within the European Union. Our comprehensive IloT offering, based on the latest industry standards, preserves the integrity of your data by encrypting it from end to end.

In order to fully meet the requirements of our customers and to be able to offer flexible solutions that are as compatible as possible, WIKa cooperates with leading technical organisations and companies.

Data security has the highest priority – which is why all WIKa

### Our partners



# IIoT products



## NETRIS®1

Radio unit with LoRaWAN® for WIKA measuring instruments

Ingress protection	IP65, IP67
Accuracy	<ul style="list-style-type: none"> <li>■ RTD: <math>\leq \pm 0.1\%</math> of span</li> <li>■ RTD, potentiometer: <math>\leq \pm 0.10\%</math> of span</li> <li>■ Analogue: <math>\leq \pm 0.1\%</math> of span</li> </ul>
Transmission range	10 km [6 mi]
Function	<ul style="list-style-type: none"> <li>■ Register</li> <li>■ Configuration of measuring and transmission rate</li> <li>■ Sending measured values</li> <li>■ Alarm management</li> <li>■ Battery status</li> </ul>
Data sheet	AC 40.01



## PEW-1000

Pressure sensor with wireless transmission for general industrial applications

Ingress protection	IP54, IP67 and IP65
Accuracy	$\leq \pm 0.5\%$ of span
Transmission range	10 km [6 mi]
Measuring range	<ul style="list-style-type: none"> <li>■ 0 ... 0.4 to 0 ... 1,000 bar</li> <li>[0 ... 1 to 0 ... 15,000 psi] as well as vacuum and <math>\pm</math> measuring ranges</li> </ul>
Data sheet	PE 87.23



## TRW

Resistance thermometer with wireless transmission for general industrial applications

Ingress protection	IP67
Accuracy	$\leq 0.1\%$ of span
Transmission range	10 km [6 mi]
Measuring range	-196 ... +500 °C [-321 ... 932 °F]
Data sheet	TE 63.04



## PGW23.100, PGW26.100

Bourdon tube pressure gauge with wireless transmission, safety version

Ingress protection	IP54, IP65 (case filling)
Accuracy class	1.0
Transmission range	10 km [6 mi]
Measuring range	<ul style="list-style-type: none"> <li>0 ... 0.6 to 0 ... 1,600 bar</li> <li>[0 ... 10 to 0 ... 20,000 psi] as well as vacuum and <math>\pm</math> measuring ranges</li> </ul>
Data sheet	PV 42.02



**NETRIS®3**  
Radio unit with LoRaWAN®

Ingress protection	IP65
Transmission range	10 km [6 mi]
Function	<ul style="list-style-type: none"> <li>■ Registration</li> <li>■ Configuration of measuring and transmission rate</li> <li>■ Sending measured values</li> <li>■ Alarm management</li> </ul>
Data sheet	AC 40.03



**PGU23.100, PGU26.100**  
Bourdon tube pressure gauge for connection to NETRIS®3 radio unit, safety version

Ingress protection	IP54, IP65 (case filling)
Accuracy class	1.0
Measuring range	0 ... 0.6 to 0 ... 1,600 bar [0 ... 10 to 0 ... 20,000 psi] as well as vacuum and ± measuring ranges
Data sheet	PV 42.03



**PEU-20, PEU-21**  
Pressure transmitter for connection to NETRIS®3 radio unit

Ingress protection	IP66/IP67
Accuracy	<ul style="list-style-type: none"> <li>■ ≤ 0.1 % of span</li> <li>■ ≤ 0.5 % of span at &gt; 1,000 bar</li> </ul>
Process connection for hygienic applications	
Measuring range	<ul style="list-style-type: none"> <li>■ 0 ... 1 to 0 ... 1,600 bar [0 ... 15 to 0 ... 20,000 psi] as well as vacuum and ± measuring range</li> </ul>
Data sheet	PE 87.24



**TGU73.100**  
Gas-actuated thermometer for connection to NETRIS®3 radio unit

Ingress protection	IP65
Accuracy class	2.0
Measuring range	-170 ... +600 °C [-274 ... +1,112 °F]
Data sheet	TV 17.13



**TRU**  
Miniature resistance thermometer for connection to NETRIS®3 radio unit

Ingress protection	IP66, IP67
Accuracy	<ul style="list-style-type: none"> <li>■ Measuring range ≤ 300 °C: ±1.9 °K</li> <li>■ Measuring range ≤ 300 °C: ±2.9 °K</li> </ul>
Measuring range	-196 ... +500 °C [-321 ... 932 °F]
Data sheet	TE 63.03



**FLRU**  
Reed level transmitter for connection to NETRIS®3 radio unit

Ingress protection	IP66, IP68
Accuracy	<ul style="list-style-type: none"> <li>■ 2.7 mm [0.11 in]</li> <li>■ 5.5 mm [0.22 in]</li> <li>■ 7.5 mm [0.30 in]</li> <li>■ 9 mm [0.35 in]</li> </ul>
Guide tube length	Max. 6,000 mm [236.22 in]
Data sheet	LM 20.13

# Digital pressure gauges

## High-quality digital pressure gauges from WIKA

Precision digital pressure gauges are suitable for stationary and also mobile measurement and indication of pressures. In addition, a digital pressure gauge can be used as a pressure reference and enables the easy testing, adjustment and calibration of other pressure measuring equipment directly on-site. Through efficient measuring cells with electronic linearisation of the characteristic curve, a high accuracy is achieved.



**CPG1200**  
Digital pressure gauge

Measuring range	-1 ... 1,000 bar
Accuracy	Down to 0.25 % FS
Special feature	<ul style="list-style-type: none"> <li>■ Integrated data logger</li> <li>■ WIKA-Cal compatible</li> <li>■ Data transmission via USB or Bluetooth®</li> <li>■ Robust case, IP65</li> </ul>
Data sheet	CT 10.20



**CPG1500**  
Precision digital pressure gauge

Measuring range	0 ... 10,000 bar
Accuracy	Down to 0.025 % FS
Special feature	<ul style="list-style-type: none"> <li>■ Integrated data logger</li> <li>■ WIKA-Cal compatible</li> <li>■ Data transmission via Bluetooth®</li> <li>■ Password protection possible</li> <li>■ Robust case, IP65</li> </ul>
Data sheet	CT 10.51



**DTK1X00**

Test case incl. digital pressure gauge model CPG1200 or CPG1500

<ul style="list-style-type: none"> <li>■ Simple data transmission via USB or Bluetooth®</li> <li>■ Optional data logger for up to 1 million data points</li> <li>■ Precise adjustment through the fine adjustment valve</li> <li>■ Clear and simple operation</li> <li>■ The right hand test pump for every pressure range</li> <li>■ Data sheet: CT 93.03</li> </ul>
---



**DMK1200**

Measuring case incl. digital pressure gauge model CPG1200

<ul style="list-style-type: none"> <li>■ Simple data transmission via USB or Bluetooth®</li> <li>■ Optional data logger for up to 1 million data points</li> <li>■ Supports the series MINIMESS® 1620 or MINIMESS® 1215 quick coupling systems</li> <li>■ Data sheet: CT 93.04</li> </ul>
---

# Hand-helds, calibrators

Hand-helds are portable calibration instruments for mobile use for the accurate measurement and recording of pressure profiles. There are interchangeable pressure sensors with measuring ranges of up to 10,000 bar available for the instruments. Through this, hand-helds are particularly suitable as test instruments for a

large variety of applications in the widest range of industries. Data recorded in the hand-held can be evaluated via PC software, some instruments document calibrations in the internal memory, which are later read on a PC. Optionally, a calibration certificate can be generated with our calibration software WIKA-Cal.



**CPH6200, CPH6210**  
Hand-held pressure indicator

Measuring range	-0.025 ... +0.025 to -1 ... 1,000 bar
Accuracy	0.2 %, 0.1 % (optional)
Special feature	<ul style="list-style-type: none"> <li>■ Integrated data logger</li> <li>■ Differential pressure measurement (optional)</li> <li>■ Ex version: Model CPH6210 (optional)</li> </ul>
Data sheet	CT 11.01, CT 11.02



**CPH6300**  
Hand-held pressure indicator

Measuring range	-0.025 ... +0.025 to -1 ... 1,000 bar
Accuracy	0.2 %, 0.1 % (optional)
Special feature	<ul style="list-style-type: none"> <li>■ Robust and waterproof case with IP65, IP67</li> <li>■ Integrated data logger</li> <li>■ Differential pressure measurement (optional)</li> </ul>
Data sheet	CT 12.01

**Complete test and service cases**



These cases can be assembled exactly to your requirements. Thus you will be fully equipped on-site!

# Hand-helds, calibrators



**CPH7000, CPH7000-Ex**  
Portable process calibrator

Measuring range	-1 ... 25 bar (-1 ... 10,000 bar with CPT7000)
Accuracy	0.025 % FS
Special feature	<ul style="list-style-type: none"> <li>■ Integrated pressure generation</li> <li>■ Measurement of pressure, temperature, current, voltage, ambient conditions</li> <li>■ Data transmission via WIKA-Wireless</li> <li>■ Supply of pressure, current and voltage</li> <li>■ Calibration function, data logger, switch test</li> </ul>
Data sheet	CT 15.51



**CPH8000**  
Portable multi-function calibrator

Measuring range	■ -1 ... 700 bar
Accuracy	0.025 % FS
Special feature	<ul style="list-style-type: none"> <li>■ Large display with touchscreen</li> <li>■ Integrated data logger and calibration function</li> <li>■ Measurement and simulation of temperature, current, voltage, resistance, frequency, pressure</li> <li>■ HART® communication</li> </ul>
Data sheet	CT 18.03



**WIKA-Cal**  
Calibration software, accessories for digital pressure gauges

<ul style="list-style-type: none"> <li>■ Creation of calibration certificates for mechanical and electronic pressure measuring instruments</li> </ul>
<ul style="list-style-type: none"> <li>■ Fully automatic calibration with pressure controllers</li> </ul>
<ul style="list-style-type: none"> <li>■ For the recording of certificate-relevant data in combination with the CalibratorUnits of the CPU6000 series</li> </ul>
<ul style="list-style-type: none"> <li>■ Determination of the required mass loads for pressure balances</li> </ul>
<ul style="list-style-type: none"> <li>■ Calibration of gauge pressure measuring instruments with absolute pressure references and vice versa</li> </ul>
Data sheet: CT 95.10



# Precision pressure measuring instruments

Precision pressure measuring instruments are electrical measuring systems which convert pressure into an electrical signal and optionally visualise it. Precise pressure transmitters and process transmitters are used for the monitoring and control of particularly sensitive processes.

Due to the low, DAkkS-accredited measurement uncertainty of down to 0.008 % of the entire measuring chain, the particularly accurate instruments find their primary applications as a factory/working standard for testing and/or calibrating a variety of pressure measuring instruments.



**ERC**

**CPT2500**  
USB pressure sensor

Measuring range	0 ... 0.025 to 0 ... 1,000 bar
Accuracy	0.2 %, 0.1 % (optional)
Special feature	<ul style="list-style-type: none"> <li>■ Recording interval adjustable from 1 ms ... 10 s</li> <li>■ No external voltage supply required</li> <li>■ Data storage and evaluation directly via PC</li> </ul>
Data sheet	CT 05.01



**mensor**

**CPT6030**  
Analogue pressure transducer

Measuring range	0 ... 0.025 to 0 ... 1,000 bar
Accuracy	0.025 %
Medium	Non-corrosive gases, liquids > 350 mbar
Special feature	<ul style="list-style-type: none"> <li>■ Comp. temperature range -20 ... +75 °C</li> <li>■ 4 ... 20 mA</li> <li>■ DC 15 ... 28 V</li> <li>■ Ingress protection IP67</li> </ul>
Data sheet	CT 25.14



**mensor**

**CPT6100, CPT6140, CPT6180**  
Precision pressure sensor

Measuring range	0 ... 0.025 to 0 ... 400 bar
Accuracy	0.01 %, 0.025 % (for CPT6140)
Medium	Non-corrosive gases, liquids > 1 bar
Special feature	<ul style="list-style-type: none"> <li>■ RS-232 or RS-485 connection</li> <li>■ Analogue output (optional)</li> <li>■ Barometric measuring range: 552 ... 1,172 mbar abs., 0.01 % of reading</li> <li>■ Measuring rate of 4 ms at CPT6140</li> </ul>
Data sheet	CT 25.10, CT 25.11



**mensor**

**CPT9000, CPT6020**  
Precision pressure sensor

Measuring range	0 ... 0.025 to 0 ... 1,000 bar
Accuracy	<ul style="list-style-type: none"> <li>■ CPT9000: 0.008 %</li> <li>■ CPT6020: 0.02 %</li> </ul>
Medium	Non-corrosive gases, liquids > 350 mbar
Special feature	<ul style="list-style-type: none"> <li>■ Comp. temperature range 0 ... 50 °C</li> <li>■ RS-232 or RS-485</li> <li>■ Measuring rate 20 ms</li> <li>■ Barometric measuring range: 552 ... 1,172 mbar abs., 0.008 % of reading</li> <li>■ Resolution 100 ppb or better</li> </ul>
Data sheet	CPT9000: CT 25.12 CPT6020: CT 25.13



**mensor**

**CPG2500**  
Precision pressure measuring instrument

Measuring range	0 ... 0.025 to 0 ... 2,890 bar
Accuracy	0.014 %, 0.01 % and 0.008 %
Medium	Non-corrosive gases, liquids > 1 bar
Special feature	<ul style="list-style-type: none"> <li>■ Up to 2 exchangeable, internal sensors and 1 external sensor of model CPT9000 or CPT6100</li> <li>■ Barometric reference (optional)</li> <li>■ Delta and leak test available</li> </ul>
Data sheet	CT 25.02



**mensor**

**CPA2501**  
Precision air data test indicator

Measuring range	<ul style="list-style-type: none"> <li>■ Altitudes to 100,000 ft</li> <li>■ Speeds to 1,150 knots</li> </ul>
Accuracy	0.01 %, 0.009 %
Special feature	<ul style="list-style-type: none"> <li>■ RVSM-compliant</li> <li>■ Ps, Qc, Ps/Pt or Ps/Qc configuration with virtual channels</li> <li>■ Altitude and airspeed rate indication</li> </ul>
Data sheet	CT 29.02

# Pressure controllers

## WIKA pressure controllers: Always the right calibration solution

Pressure controllers are electronic controllers which quickly and automatically provide a stable pressure reference. Due to the high accuracy and control stability, pressure controllers are especially suitable as references for production lines and laboratories, in order to carry out automatic testing and/or calibration of all types of sensors.

With pneumatic ranges from 1 mbar to 700 bar and hydraulic ranges to 1,600 bar, the pressure controllers cover a wide range. Each controller represents a breakthrough in control and measurement technology to provide first-class measurement accuracy and highly stable pressure control.



**Wika**

**CPC2000**  
Low-pressure version

Measuring range	0 ... 1 to 0 ... 1,000 mbar
Accuracy	0.1 % / 0.3 % (for 0 ... 1 mbar)
Medium	Ambient air
Special feature	<ul style="list-style-type: none"> <li>■ Integrated pressure generation</li> <li>■ Integrated rechargeable battery</li> </ul>
Data sheet	CT 27.51



**Wika**

**CPC4000**  
Industrial series

Measuring range	0 ... 0.35 to 0 ... 210 bar
Accuracy	0.02 %
Control stability	0.005 %
Medium	Dry, clean air or nitrogen
Special feature	<ul style="list-style-type: none"> <li>■ Up to 2 sensors</li> <li>■ Fast control speed</li> <li>■ Leak test function</li> <li>■ Automatic contamination protection (optional)</li> <li>■ Up to 24 internal programmable sequences</li> </ul>
Data sheet	CT 27.40



**Wika**

**CPC6050**  
Modular version

Measuring range	0 ... 0.025 to 0 ... 210 bar
Accuracy	0.008 %
Control stability	0.003 %
Medium	Dry, clean air or nitrogen
Special feature	<ul style="list-style-type: none"> <li>■ Up to 2 control/measuring channels with 2 sensors each</li> <li>■ Sensors exchangeable</li> <li>■ Switch test function</li> <li>■ Auto-channel for both controllers</li> <li>■ Automatic contamination protection (optional)</li> </ul>
Data sheet	CT 27.62



**CPC8000**  
Pneumatic pressure controllers,  
premium version

Measuring range	0 ... 0.35 to 0 ... 400 bar
Accuracy	0.01 ... 0.008 %
Control stability	0.002 %
Medium	Dry, clean air or nitrogen
Special feature	<ul style="list-style-type: none"> <li>■ Excellent control stability and pressure control without overshooting</li> <li>■ Up to three interchangeable sensors</li> <li>■ Optional barometer for automatic conversion of the pressure type</li> <li>■ Control performance can be matched to application</li> </ul>
Data sheet	CT 28.01



**CPC7000**  
Pneumatic pressure controllers,  
high-pressure version

Measuring range	0 ... 100 bar to 0 ... 700 bar
Accuracy	0.01 %
Control stability	0.008 %
Medium	Nitrogen
Special feature	<ul style="list-style-type: none"> <li>■ Robust and low-wear valve technology with long-term stability</li> <li>■ Up to three interchangeable sensors</li> <li>■ 6 x digital I/O</li> <li>■ High-pressure safety</li> </ul>
Data sheet	CT 27.63



**CPC8000-H**  
Hydraulic pressure controller,  
high-pressure version

Measuring range	0 ... 100 to 0 ... 2,895 bar
Accuracy	0.014 % ... 0.01 %
Control stability	0.005 %
Medium	Hydraulic oil or water
Special feature	<ul style="list-style-type: none"> <li>■ High stability</li> <li>■ Up to two interchangeable reference sensors</li> <li>■ Automatic flooding</li> <li>■ Hydraulic liquids available, e.g. Sebacate, Shell Tellus 22, Krytox, FC77</li> </ul>
Data sheet	CT 28.05

**For aviation**

**An air data test set is an electronic controller which provides a pressure at a variable and adjustable rate.**

Air data test sets are specifically developed to convert the pressure to be controlled into a height or rate of climb and velocity. As a result of the high accuracy, control stability and ability to simulate altitude and velocity, an air data test set is particularly suitable as a reference for aircraft workshops and also for instrument manufacturers and calibration laboratories in the aviation industry, in order to make calibrations on sensors and displays.



**CPA8001**  
Air data test set

Measuring range	<ul style="list-style-type: none"> <li>■ Altitudes to 100,000 ft</li> <li>■ Speeds to 1,150 knots</li> </ul>
Accuracy	0.01 % ... 0.009 %
Control stability	0.002 %
Medium	Dry, clean air or nitrogen
Special feature	<ul style="list-style-type: none"> <li>■ Excellent control stability, even with rate control</li> <li>■ Overshoot-free control</li> <li>■ RVSM compatible</li> <li>■ Configurations Ps/Pt, Ps/Qc</li> </ul>
Data sheet	CT 29.01

# Pressure balances

## Industrial series

### Compact and competitively priced dead-weight testers for use on-site or for maintenance and service

The compact dimensions and low weight are key features of these dead-weight testers for their daily use in service and maintenance. With their integrated pressure generation and purely mechanical measurement principle, they are also specifically suited to on-site applications.



#### CPB3500

Pneumatic compact version

Measuring range	0.015 ... 1 to 1 ... 120 bar
Accuracy	0.015 ... 0.006 %
Medium	Non-corrosive gases
Special feature	<ul style="list-style-type: none"> <li>■ Compact dimensions and low weight</li> <li>■ 1 bar piston can be used for positive and negative overpressure</li> </ul>
Data sheet	CT 31.22



#### CPB3800

Hydraulic compact version

Measuring range	1 ... 120 to 10 ... 1,200 bar
Accuracy	0.05 ... 0.025 %
Medium	Special oil
Special feature	<ul style="list-style-type: none"> <li>■ Compact dimensions and low weight</li> <li>■ Instrument base can now also be combined with the CPB5800 piston-cylinder systems</li> </ul>
Data sheet	CT 31.06



#### CPB3800HP

Compact, high-pressure version with dual-range piston-cylinder system

Measuring range	1 ... 2,600 bar
Accuracy	0.025 ... 0.007 %
Medium	Special oil or others on request
Special feature	<ul style="list-style-type: none"> <li>■ Dual-range piston-cylinder systems with automatic changing between ranges</li> <li>■ Compact dimensions and low weight</li> </ul>
Data sheet	CT 31.07

#### CPU6000 series

CalibratorUnit



- Determination of the required mass loads or the reference pressure for calibration with pressure balances
- Recording of certificate-relevant data
- Calibration of gauge pressure measuring instruments with absolute pressure references and vice versa
- Easy calibration of pressure transmitters through the voltage supply and multimeter function

Data sheet: CT 35.02

## Laboratory version

### High-performance primary standards with excellent running characteristics for use in calibration laboratories

Through modern instrument design with excellent equipment features, the highest demands of operator convenience and performance are fulfilled. The selection of dual-range piston-cylinder systems with automatic changing between ranges can ensure this measurement uncertainty over a large pressure range, even with a single measuring system.



**CPB5000**  
Pneumatic version

Measuring range	-0.03 ... -1 to 0.4 ... 100 bar
Accuracy	0.015 ... 0.008 %
Medium	Non-corrosive gases
Special feature	Patented system for fast piston-cylinder exchange
Data sheet	CT 31.01



**CPB5000HP**  
High-pressure version

Measuring range	25 ... 2,500 to 25 ... 6,000 bar
Accuracy	0.025 ... 0.02 %
Medium	Special oil
Special feature	Robust instrument base with integrated high-pressure generation
Data sheet	CT 31.51



**CPB5800**  
Hydraulic version with dual-range piston-cylinder systems

Measuring range	1 ... 120 to 1 ... 1,400 bar
Accuracy	0.015 ... 0.006 %
Medium	Special oil or others on request
Special feature	<ul style="list-style-type: none"> <li>■ Dual-range piston-cylinder systems with automatic changing between ranges</li> <li>■ Instrument base can now also be combined with the CPS5000 piston-cylinder systems</li> </ul>
Data sheet	CT 31.11



**CPB5600DP**  
Differential pressure version

Measuring range	0.03 ... 2 to 25 ... 1,600 bar
Accuracy	0.015 ... 0.008 %
Medium	Non-corrosive gases or special oil
Special feature	Two complete pressure balances within one case for real differential pressure measurements under static pressure
Data sheet	CT 31.56

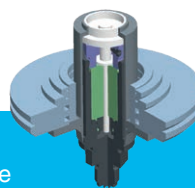

**CPS5000**  
Hydraulic single-range piston-cylinder systems

Special feature	<ul style="list-style-type: none"> <li>■ For the highest demands on accuracy and performance</li> <li>■ Can be combined with the CPB5800 instrument base</li> </ul>
Data sheet	CT 31.01

# Pressure balances

## High-end version

### High-accuracy and high-performance primary standards with excellent operating characteristics, based on the physical principle of Pressure = Force/Area

The direct measurement of the pressure ( $p = F/A$ ), as well as the use of high-quality materials enable this small measurement uncertainty, in conjunction with an excellent long-term stability (recommended recalibration interval of five years in accordance with the German Calibration Service DKD/DAkkS). Furthermore, an automatic mass handling system and pressure generation ensure fully automatic calibration. The pressure balance has therefore been used for years in factory and calibration laboratories in industry, national institutes and research laboratories, and also in production by sensor and transmitter manufacturers.



#### CPB6000

Highest-accuracy primary standard

Measuring range	4 ... 5,000 bar
Accuracy	0.0035 ... 0.0015 %
Medium	Dry, clean air, nitrogen or special oil
Special feature	Different instrument variants for the highest demands
Data sheet	CT 32.01



#### CPB6000DP

Primary standard for differential pressure

Measuring range	30 ... 800 bar
Accuracy	0.005 ... 0.002 %
Medium	Non-corrosive gases
Special feature	For differential pressure measurements from 10 Pa to 800 bar
Data sheet	CT 32.02



#### CPD8500

Digital pressure balance

Measuring range	1 ... 500 bar (abs. and gauge)
Accuracy	0.005 ... 0.0035 %
Medium	Non-corrosive, dry gases
Special feature	<ul style="list-style-type: none"> <li>■ Unique principle of operation based on SI units</li> <li>■ Intuitive operator interface</li> <li>■ Automatic calibrations, no mass handling needed</li> <li>■ Automatic compensation of the ambient conditions</li> </ul>

Data sheet CT 32.05

# Calibration software

## Easy and fast creation of a high-quality calibration certificate

WIKA-Cal calibration software enables an automated calibration process with the subsequent creation of calibration certificates (Cal-Template) or logger protocols (Log-Template) for pressure measuring instruments. It is available as a demo version for free download from the homepage. Alongside the simple operation of the software, WIKA-Cal supports the user in the document creation process.

With the purchase of a USB dongle with the desired licence, the range of functions of the demo version is automatically extended while the USB dongle is plugged in and these functions are available so long as the USB dongle is connected to the computer.



### WIKA-Cal

Calibration software, accessories for digital pressure gauges

- Creation of calibration certificates for mechanical and electronic pressure measuring instruments
- Fully automatic calibration with pressure controllers
- For the recording of certificate-relevant data in combination with the CalibratorUnits of the CPU6000 series
- Determination of the required mass loads for pressure balances
- Calibration of gauge pressure measuring instruments with absolute pressure references and vice versa

Data sheet: CT 95.10

## In addition to the demo version, three WIKA-Cal licences are available in connection with a precision pressure measuring instrument

The WIKA-Cal calibration software is available for online calibrations together with a PC. The scope of software functions depends on the selected licence. Several licences can be combined on one USB dongle.

Cal-Template (demo version)	Cal-Template (light version)	Cal-Template (full version)
<ul style="list-style-type: none"> <li>■ Fully automatic calibration</li> <li>■ Limitation to two measuring points</li> </ul>	<ul style="list-style-type: none"> <li>■ Semi-automatic calibration</li> <li>■ No limitation of the measuring points</li> </ul>	<ul style="list-style-type: none"> <li>■ Fully automatic calibration</li> <li>■ No limitation of the measuring points</li> </ul>
<ul style="list-style-type: none"> <li>■ Creating calibration certificates per DIN EN 10204</li> <li>■ Calibration reports can be exported to Excel® template or XML file</li> <li>■ Calibration of gauge pressure measuring instruments with absolute pressure references and vice versa</li> </ul>		

Log-Template (demo version)	Log-Template (full version)
<ul style="list-style-type: none"> <li>■ Limitation to five measuring points</li> </ul>	<ul style="list-style-type: none"> <li>■ No limitation of the measuring points</li> </ul>
<ul style="list-style-type: none"> <li>■ Live measured value recording for a certain period of time with selectable interval, duration and start time</li> <li>■ Creation of logger protocols with graphic and/or tabular representation of the measuring results in PDF format</li> <li>■ Possibility of exporting measuring results as CSV file</li> </ul>	

## Multicalibration

The "Multicalibration" licence available for an additional charge can be ordered in addition to Cal Light or Cal. With this, it is possible to calibrate, incl. documentation, up to 16 test items simultaneously. The prerequisite is that the test items are of the same instrument model, measuring range and accuracy.

For pressure sensors, it is possible to use either several multimeters (such as model CPU6000-M, for example) or a multiplexer to which all multimeters will be connected.

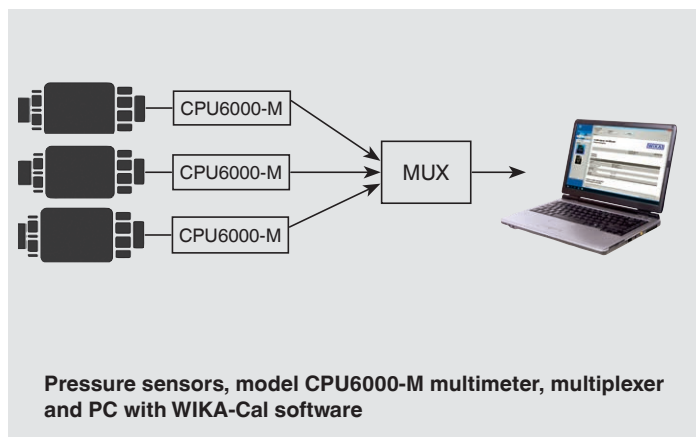

# Pressure generation

## Portable pressure generation

Hand test pumps serve as pressure generators for the testing, adjustment and calibration of mechanical and electronic pressure measuring instruments through comparative measurements. These pressure tests can take place in the laboratory or workshop, or on-site at the measuring location.



**CPP10-H**  
Pneumatic hand test pump

Measuring range	-0.85 ... +10 bar
Medium	Ambient air
Special feature	<ul style="list-style-type: none"> <li>■ Switchable pressure/vacuum generation</li> <li>■ Precise adjustment through the fine adjustment valve</li> <li>■ Simple and ergonomic handling</li> <li>■ Compact dimensions and low weight</li> </ul>
Data sheet	CT 91.10

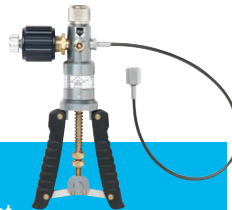

**CPP30**  
Pneumatic hand test pump

Measuring range	-950 mbar ... +35 bar
Medium	Ambient air
Special feature	<ul style="list-style-type: none"> <li>■ Pressure and vacuum generation switchable</li> <li>■ Compact dimensions</li> </ul>
Data sheet	CT 91.06



**CPP700-H, CPP1000-H**  
Hydraulic hand test pump

Measuring range	0 ... 700 or 0 ... 1,000 bar
Medium	Oil or water
Special feature	<ul style="list-style-type: none"> <li>■ Integrated medium reservoir</li> <li>■ Ergonomic handling</li> </ul>
Data sheet	CT 91.07

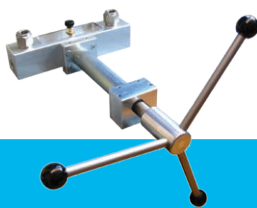

**CPP1000-M, CPP1000-L**  
Hydraulic hand spindle pump

Measuring range	0 ... 1,000 bar
Medium	Oil or water
Special feature	<ul style="list-style-type: none"> <li>■ Smooth-running, internally operating precision spindle</li> <li>■ Compact dimensions</li> </ul>
Data sheet	CT 91.05



## Pressure generation in the laboratory

Comparison test pumps serve as pressure generators or controllers for the testing, adjustment and calibration of mechanical and electronic pressure measuring instruments. Due to their stable case, these test pumps are particularly suitable for stationary use in laboratories or workshops.



### CPP120-X

Pneumatic comparison test pump

Measuring range	0 ... 120 bar
Medium	Clean, dry, non-corrosive gases
Special feature	<ul style="list-style-type: none"> <li>■ Accurate pressure setting</li> <li>■ Robust industrial series</li> <li>■ External initial pressure supply necessary</li> </ul>
Data sheet	CT 91.03



### CPP1200-X

Hydraulic comparison test pump

Measuring range	0 ... 1,200 bar
Medium	Oil or water
Special feature	<ul style="list-style-type: none"> <li>■ Integrated tank</li> <li>■ Dual-area spindle pump</li> <li>■ Robust industrial series</li> </ul>
Data sheet	CT 91.08



### CPP4000-X

Hydraulic comparison test pump

Measuring range	0 ... 1,200 bar
Medium	Oil or water
Special feature	<ul style="list-style-type: none"> <li>■ Integrated tank</li> <li>■ Dual-area spindle pump</li> <li>■ Robust industrial series</li> </ul>
Data sheet	CT 91.09



### CPP1000-X, CPP1600-X

Hydraulic comparison test pump

Measuring range	0 ... 1,000 to 0 ... 1,600 bar
Medium	Oil or water
Special feature	<ul style="list-style-type: none"> <li>■ Integrated tank</li> <li>■ Robust laboratory version with priming pump</li> <li>■ Compact industrial series with priming pump</li> </ul>
Data sheet	CT 91.12

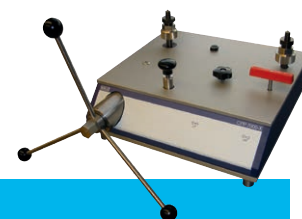

### CPP7000-X

Hydraulic comparison test pump

Measuring range	0 ... 7,000 bar
Medium	Sebacate oil
Special feature	<ul style="list-style-type: none"> <li>■ Integrated tank</li> <li>■ Robust laboratory version with priming pump</li> </ul>
Data sheet	CT 91.13

# Reference thermometers

## Highly accurate temperature measurement with reference thermometers

Reference thermometers (standard thermometers) are, due to their excellent stability and their geometrical adaptations, ideally suited for applications in industrial laboratories. They enable easy comparative calibration in baths, in tube furnaces and in dry-well calibrators. The advantage of reference thermometers is the wide temperature range, and with this, their flexible operation. Furthermore, with their low drift, a long service life is ensured.

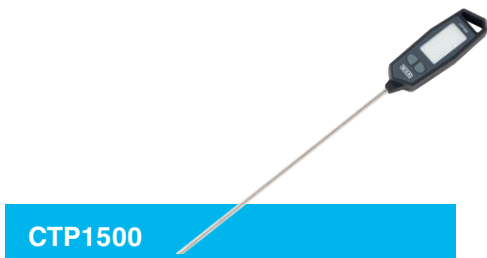

**CTP1500**  
Digital thermometer

Measuring range	-50 ... +250 °C
Accuracy	<ul style="list-style-type: none"> <li>■ ±0.05 K at -20 ... +180 °C</li> <li>■ ±0.15 K in remainder of range</li> </ul>
Dimensions	Depending on version
Special feature	<ul style="list-style-type: none"> <li>■ Digital display in the handle</li> <li>■ Battery powered</li> </ul>
Data sheet	CT 61.05



**CTP2000**  
Platinum resistance thermometer

Measuring range	-200 ... +450 °C
Stability	< 50 mK after 100 h at 450 °C
Dimensions	Ø 4 mm, l = 500 mm
Special feature	<ul style="list-style-type: none"> <li>■ 4-wire connection</li> <li>■ Ends with 4 mm banana plugs</li> </ul>
Data sheet	CT 61.10



**CTP5000**  
Reference thermometer

Measuring range	-196 ... +660 °C
Probe type	Pt100, Pt25
Dimensions	Depending on version
Special feature	<ul style="list-style-type: none"> <li>■ Flying leads</li> <li>■ DIN or SMART connector</li> </ul>
Data sheet	CT 61.20



**CTP6000**  
Reference thermometer

Measuring range	-200 ... +420 °C
Probe type	Pt100
Dimensions	Depending on version
Special feature	<ul style="list-style-type: none"> <li>■ Flying leads</li> <li>■ DIN or SMART connector</li> </ul>
Data sheet	CT 61.30



**CTP9000**  
Thermocouple

Measuring range	0 ... 1,600 °C
Thermocouple	Type S per IEC 584, class 1
Dimensions	Depending on version
Special feature	<ul style="list-style-type: none"> <li>■ Cold junction optional</li> <li>■ 2,000 mm cable</li> </ul>
Data sheet	CT 61.10

# Hand-helds

Hand-helds are portable calibration instruments for mobile use for the accurate measurement and recording of temperature profiles. For the instruments there are various designs of thermometers available. Through this, hand-helds are particularly suitable as test instruments for a large variety of applications in the widest range of industries.

Data recorded in the hand-held can be evaluated via PC software, some instruments document calibrations in the internal memory, which are later read on a PC. Optionally, a calibration certificate can be generated with our calibration software WIKA-Cal.



EAC

**CTH6200**  
Hand-held thermometer

Measuring range	-50 ... +250 °C
Accuracy	< 0.2
Probe type	Pt100
Special feature	Integrated data logger
Data sheet	CT 51.01



EAC Ex

**CTH6300,  
CTH6310**  
Hand-held thermometer

Measuring range	-200 ... +1,500 °C
Accuracy	0.1 ... 1 K
Probe type	Pt100, TC
Special feature	<ul style="list-style-type: none"> <li>■ 2 channels (optional)</li> <li>■ Ex version: Model CTH6310</li> </ul>
Data sheet	CT 51.05



EAC Ex

**CTH6500,  
CTH6510**  
Hand-held thermometer

Measuring range	-200 ... +1,500 °C
Accuracy	0.03 ... 0.2 K
Probe type	Pt100, TC
Special feature	<ul style="list-style-type: none"> <li>■ Integrated data logger (optional)</li> <li>Ex version: Model CTH6510</li> </ul>
Data sheet	CT 55.10

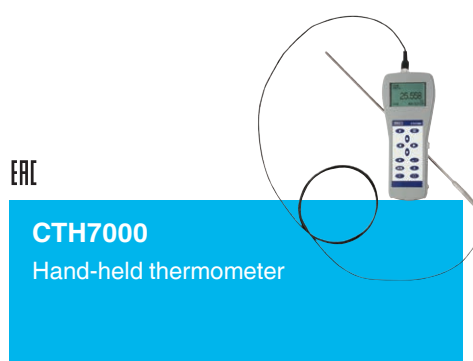

EAC

**CTH7000**  
Hand-held thermometer

Measuring range	-200 ... +962 °C
Accuracy	0.015 K
Probe type	Pt100, Pt25 and NTC
Special feature	Integrated data logger
Data sheet	CT 55.50



**CTR1000**  
Infrared hand-held  
thermometer

Measuring range	-60 ... +1,000 °C
Accuracy	2 K or 2 % of reading
Special feature	Thermocouple connection (optional)
Data sheet	CT 55.21

# Calibration baths

Calibration baths are electronic controllers which automatically, quickly and with the help of a liquid supply a temperature. Due to the high reliability, accuracy and exceptional homogeneity in the measuring chamber, calibration baths are particularly suitable as a factory/working standard for the automatic testing and/or calibration of the widest range of temperature probes - independent of diameter. A special micro calibration bath design enables on-site applications.



**CTB9100**  
Micro calibration bath

Measuring range	-35 ... +255 °C
Accuracy	±0.2 ... 0.3 K
Stability	±0.05 K
Special feature	<ul style="list-style-type: none"> <li>■ Short heating and cooling times</li> <li>■ Easy to use</li> </ul>
Data sheet	CT 46.30



**CTM9350-165**  
Multi-function calibrator,  
premium version

Measuring range	-35 ... +165 °C depending on the application
Accuracy	±0.07 ... 0.5 K depending on the application
Immersion depth	150 mm
Special feature	Use as a dry-well calibrator, micro calibration bath, surface temperature calibrator and infrared black body
Data sheet	CT 41.41



**CTB9400**  
Calibration bath,  
medium measuring range

Measuring range	28 ... 300 °C
Stability	±0.02 K
Immersion depth	200 mm
Medium	Water, oil or similar media
Data sheet	CT 46.20



**CTB9500**  
Calibration bath,  
low measuring range

Measuring range	-45 ... +200 °C
Stability	±0.02 K
Immersion depth	200 mm
Medium	Water, oil or similar media
Data sheet	CT 46.20

# Portable temperature calibrators

Portable temperature calibrators (dry-well calibrators) are electronic controllers which automatically, quickly and dryly supply a temperature. Due to the high reliability, accuracy and simple operation, portable temperature calibrators are particularly suitable as a factory/working standard for the automatic testing and/or calibration of temperature measuring instruments of all types.



**CTD9100**  
Temperature dry-well calibrator

Measuring range	-55 ... +650 °C
Accuracy	±0.15 ... 0.8 K
Stability	±0.01 ... 0.05 K
Immersion depth	150 mm
Data sheet	CT 41.28



**CTD4000**  
Temperature dry-well calibrator

Measuring range	-24 ... 650 °C
Accuracy	0.25 ... 0.5 K
Stability	0.1 ... 0.3 K
Immersion depth	104 mm/150 mm
Data sheet	CT 41.10



**CTD9100-1100**  
High-temperature dry-well calibrator

Measuring range	200 ... 1,100 °C
Accuracy	±3 K
Stability	±0.3 K
Immersion depth	220 mm, bore depth 155 mm
Data sheet	CT 41.29



**CTD9350-165, CTD9350-700**  
Temperature dry-well calibrator, premium version

Measuring range	-35 ... +700 °C
Accuracy	±0.1 K
Stability	±0.008 ... 0.1 K depending on the reference
Immersion depth	150 mm
Data sheet	CT 41.39



**CTD9100-375**  
Compact temperature dry-well calibrator

Measuring range	t <sub>amb</sub> ... 375 °C
Accuracy	±0.5 ... 0.8 K
Stability	±0.05 K
Immersion depth	100 mm
Data sheet	CT 41.32



**CTI5000**  
Infrared calibrator

Measuring range	50 ... 500 °C
Stability	±0.1 ... 0.4 K
Special feature	Large diameter of measuring surface
Data sheet	CT 41.42



**CTM9350-165**  
Multi-function calibrator, premium version

Measuring range	-35 ... +165 °C depending on the application
Accuracy	±0.07 ... 0.5 K depending on the application
Immersion depth	150 mm
Special feature	Use as a dry-well calibrator, micro calibration bath, surface temperature calibrator and infrared black body
Data sheet	CT 41.41

# Resistance thermometry bridges

By using built-in or external standard resistors, resistance thermometry bridges measure resistance ratios with high accuracy, which are indicative of the temperature, among other things. These instruments are not only used in the field of temperature measurement, but – due to their high accuracy – also in electrical laboratories.

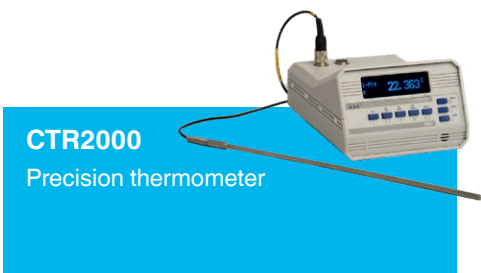

**CTR2000**  
Precision thermometer

Measuring range	-200 ... +850 °C
Accuracy	<ul style="list-style-type: none"> <li>■ 0.01 K (4-wire)</li> <li>■ 0.03 K (3-wire)</li> </ul>
Probe type	Pt100, Pt25
Special feature	<ul style="list-style-type: none"> <li>■ 3-wire measurement (optional)</li> <li>■ Up to 8 channels integrated in the instrument (optional)</li> </ul>
Data sheet	CT 60.10



**CTR3000**  
Multi-functional precision thermometer

Measuring range	-210 ... +1,820 °C
Accuracy	<ul style="list-style-type: none"> <li>■ ±0.005 K (4-wire)</li> <li>■ ±0.03 K (3-wire)</li> <li>■ ±0.004 % + 2 µV for thermocouples</li> </ul>
Probe type	Pt100, Pt25, thermocouples
Special feature	<ul style="list-style-type: none"> <li>■ Versatile applications by measuring thermocouples and resistance thermometers</li> <li>■ Logger and scan functions</li> <li>■ Up to 44 channels possible</li> </ul>
Data sheet	CT 60.15



**CTS3000**  
Multiplexer

Measuring range	-210 ... +1,820 °C
Accuracy	<ul style="list-style-type: none"> <li>■ ±0.005 K (4-wire)</li> <li>■ ±0.03 K (3-wire)</li> <li>■ ±0.004 % + 2 µV for thermocouples</li> </ul>
Probe type	Pt100, Pt25, thermocouples
Special feature	<ul style="list-style-type: none"> <li>■ No loss of accuracy</li> <li>■ Various coupler connectors connectable</li> <li>■ Complete automatic calibration routines controllable</li> </ul>
Data sheet	AC 87.01



**CTR6000**  
DC resistance thermometry bridge

Measuring range	-200 ... +962 °C
Accuracy	±3 mK (full range)
Probe type	PRT, thermistors or fixed resistors
Special feature	<ul style="list-style-type: none"> <li>■ Expendable to 60 channels (optional)</li> <li>■ Internal resistors 25 Ω, 100 Ω, 10 kΩ, 100 kΩ</li> </ul>
Data sheet	CT 60.30



**CTR6500**  
AC resistance thermometry bridge

Measuring range	-200 ... +962 °C
Accuracy	0.1 ... 1.25 mK depending on resistance ratio
Probe type	SPRT, PRT or fixed resistors
Special feature	<ul style="list-style-type: none"> <li>■ Expendable to 60 channels (optional)</li> <li>■ Internal resistors 25 Ω, 100 Ω</li> <li>■ AC technology</li> </ul>
Data sheet	CT 60.40

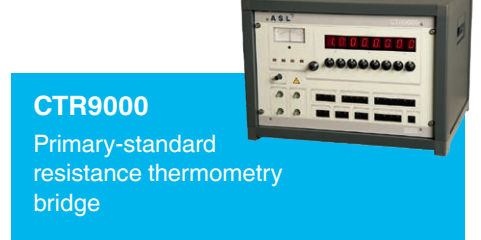

**CTR9000**  
Primary-standard resistance thermometry bridge

Measuring range	0 ... 260 Ω
Accuracy	0.01 K, optional 0.005 K
Probe type	SPRT, PRT or fixed resistors
Special feature	<ul style="list-style-type: none"> <li>■ Expendable to 60 channels (optional)</li> <li>■ 4 selectable standby currents possible (optional)</li> <li>■ AC technology</li> </ul>
Data sheet	CT 60.80

# Standard reference resistors, AC/DC

## Electrical comparison standard

Reference resistors with high-accuracy, fixed resistance values, which are used in connection with resistance thermometry bridges. They are also used as standards in accredited electrical laboratories.



**CER6000-RR**  
Reference resistor

Resistance value 1, 10, 25, 100, 300, 400, 500, 1,000 and 10,000  $\Omega$

Long-term stability <math>\leq 5</math> ppm per year

Special feature

- Low temperature coefficient
- Rugged stainless steel construction

Data sheet CT 70.30



**CER6000-RW**  
Standard reference resistor

Resistance value 1, 10, 25, 100, 300, 400, 500, 1,000 and 10,000  $\Omega$

Long-term stability  $\pm 2$  ppm per year (HS version 0.5 ppm per year)

Special feature

- Low temperature coefficient
- Rugged stainless steel construction

Data sheet CT 70.30

## Connections of the reference resistor, model CER6000-RR

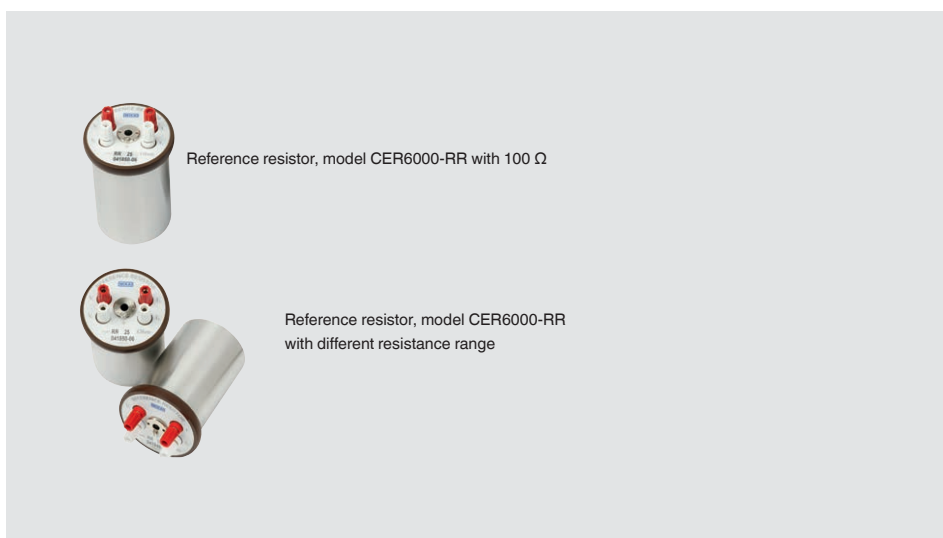
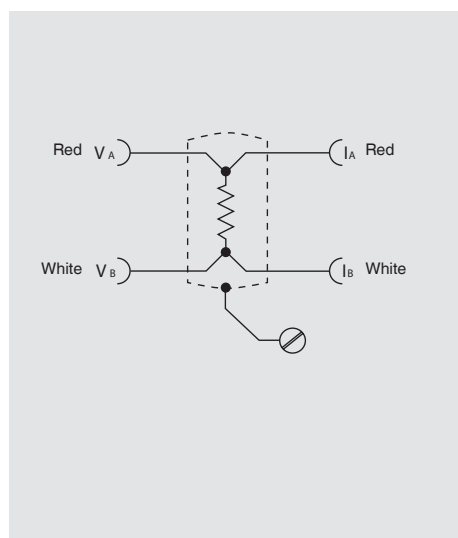

# Accessories

## From individual components ... to complete turnkey kits

The following accessory components are the ideal complement to the individual calibration instruments. Thus a complete solution is not only quickly and easily configured, but can also be installed in the same manner. The various packages complete the product programme for calibration technology and can be used in many different applications.

Customer-specific drilled inserts, silicone oil suited for calibration in micro calibration baths and interface cables complete the product portfolio for temperature.

You can find a detailed description in our catalogue "Accessories for calibration technology".



Pressure supply case



Pressure and vacuum supply packages



Connection components

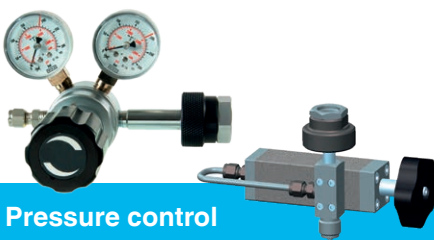

Pressure control



Calibration and adjustment tools



Temperature accessories



# Engineered solutions

We have been developing systems for use in our own group of companies for years and can draw on our own process knowledge to continually develop our systems further.

We offer robust and compact turnkey machinery from a single source, with our own fixture construction and customer-specific solutions as well as many application possibilities.

## Test and calibration systems for workshops and laboratories

For the fitting-out of calibration laboratories, we offer individually designed test workstations. Here we integrate proven calibration systems from our extensive product range into ergonomic workstations. These can be individually equipped and combined with the following components:

- 19" calibration racks in modular design for pressure sensors
- Connection columns with quick-release fasteners for test items and references with exchangeable threaded inserts
- Electric and pneumatic power strips with 230-V voltage supply and compressed air with air blow gun connection including pressure regulator
- Work panel for setting the operating pressure with inlet pressure gauge, outlet pressure gauge and alternative pressure supply
- PC workstations



## Test and calibration systems for production

The complete solutions are available in the widest range of automation levels incl. tempering units, workpiece transport systems, workpiece fixtures and electrical and pressure-side contacting.

The focus is on the precise interaction of measurement technology, testing system mechanics and control components. In addition, the actual testing and adjustment processes can also be combined with mounting and labelling processes.



## Leak and pressure function test systems for production



We offer individual and turnkey solutions in various degrees of automation for a wide variety of applications, from simple test device through semi-automatic test benches to fully automatic testing systems.

The testing processes can also be combined with assembly processes, laser marking and automated parts handling (infeed/outfeed); in addition, the chaining of several stations is possible.

### Pneumatic or helium leak testing

on fittings, valves, hoses, coolers, pumps, filters and many other test parts.

### Pressure function tests or setting procedures

among other things for

- Control pressure of pressure reducers or thermostat control valves
- The cracking pressure of safety relief valves
- Switch points of pressure switches and control valves
- Pressure containment of different components

### Test methods

Integral vacuum methods

Accumulation methods (under atmosphere)

Sniffing test

## Customer-specific laser welding machines for production

Core elements of our turnkey concept for laser welding systems are a modular axis system, both easily serviced and upgradeable, as well as our own user-friendly, Windows-based control software, for which no programming knowledge is required.

### Your benefits

- We have strong and reliable partners for the laser sources with continuous product development.
- Our systems are equipped with operator software for simple and intuitive operation without needing CNC programming knowledge.
- Our low-service axis concept can also be upgraded at a later date thanks to the modular design of the axes.
- We can be at your side from as early as the preparation of your requirements specification document and offer you the opportunity to influence the entire development phase.



### The GHP series features numerous functions and options:

- Camera systems can be integrated to check component positioning
- External interfaces
- CNC axes with servo drives
- Automatic loading possible
- 2- to 5-axis kinematics
- Automatic force-displacement controlled joining function
- Automatic fixture recognition
- Connection to the customer's ERP system

Other models of the GHP series offer further special features.

## Service for customer-specific systems

### ■ Immediate help in case of faults

For the shortest response times and efficient problem analysis we offer a remote service via smart glasses. Using smart glasses, our specialists can efficiently analyse the problem and quickly take targeted corrective action, so you benefit from reduced downtime and costs.

### ■ Preventive maintenance

Through regular system maintenance, premature wear can be prevented and the risk of system downtime can be minimised. We are happy to advise you regarding the ideal maintenance intervals and to design an individual maintenance package for you.

Service hotline: +49 9372 132 5049



Extensive information can be found in our brochure "Test benches and calibration systems" at [www.wika.com](http://www.wika.com).

# Lasting impressions with reliable services



## Choose from our comprehensive set of services

### Installation and commissioning

WIKAI's field installation experts go to the customers' sites to provide tailored solutions that result in a short downtime. Process reliability is guaranteed by expert installation. Installations include multipoint thermometers in reactors, thermocouples in furnaces and level measurement instrumentation.

### Calibration

WIKAI provides its calibration services on-site at your premises or in our laboratory, for WIKAI as well as other instruments. Pressure, temperature, mass, electrical, force, dimensional, flow and torque are some of the other calibrations and adjustments that we provide on shortest delivery times.

### Maintenance and repair

You can count on WIKAI to do repairs – from diaphragm seal systems up to highly accurate calibration instruments. We support you in optimising your operational processes. Benefit from our know-how for solutions that are tailored to your needs.

### Inspection and testing

You can rely on WIKAI for on-site verification and function testing that is non-invasive and non-destructive. Our expertise also includes in-situ verifications of multipoint thermometers.

### Analysis and support

WIKAI offers reliable consultation services, both analytical and technical, for a wide range of industries. Our qualified service technicians support in solving problems and ensure that your measuring instrument is back in working order in the shortest possible time.

**SERVICES**   
**EXCEEDING  
EXPECTATIONS**



Scan for more information



Oil and gas



Chemical and petrochemical



Power generation



Food and pharmaceutical



IIoT and digitalisation



Basic materials

For over 75 years, WIKA has helped industries all over the world meet set industry benchmarks. With time, we took it upon ourselves and our services engagement to not just meet but also exceed those set benchmarks and expectations.

We will always want to exceed your own expectations by providing the best-in-class service. Moreover, our quality of work is backed by the strength of our OEM manufacturing expertise.

To help you do more than just the best, we also ensure global consistency. To help you do more than just the best, we also ensure global consistency, which means that you can count on us for any service engagement, be it generic or customised in nature, all over the world.

## Down the street – around the world



Growing team with over 50 field service technicians and supervisors worldwide and already 15 mobile calibration vans deployed in various countries around the world.

With our ISO 17025 accredited calibration laboratory presence in over 20 countries, we assure you that we will leave no stone unturned to ensure global consistency and standard of excellence.

We ensure high quality by professional training and certification of our service technicians. The observance of health and safety aspects is very important to us.

# Industry-specific products

In our segment brochures you will find industry-specific know-how and special products explicitly developed for specific application areas.

## Ventilation and air-conditioning technology



### Sensing technology for ventilation and air-conditioning

Our mechanical and electronic instruments are used for measuring and monitoring pressure, air flow, temperature, humidity and air quality.



## Sanitary applications



### Sanitary applications

Our measuring instruments optimally fulfil requirements in terms of highest process reliability, hygienic design and the integration of sensing technology into production plants.



## SF<sub>6</sub> gas solutions



### Power transmission and distribution industry

WEgrid Solutions offers customised complete solutions for plants filled with SF<sub>6</sub> gas.



## High purity and ultra high purity

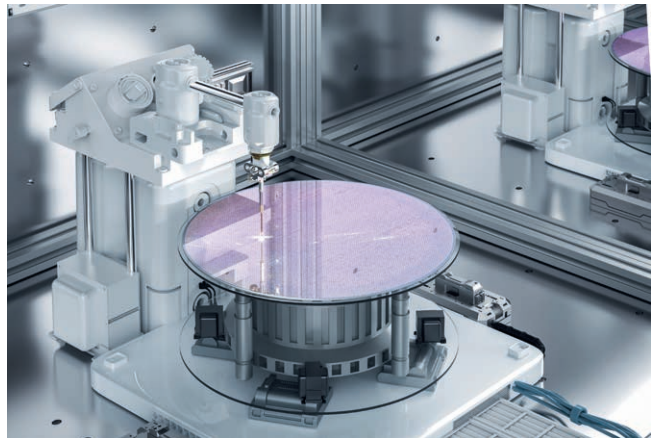

### Measurement solutions for semiconductor, solar and light-emitting technologies

High purity, media resistance, leak tightness and accuracy all make up the basic requirements for the development and production of our measuring instruments for the semiconductor industry.

# Website and social media

Visit us on our website, in our online shop and on our social media channels.



## Website

[wika.com](http://wika.com)

Find out about our wide range of measurement technology and services, or market sectors. Download 3D drawings, technical documents or informative brochures. And please register for our free newsletter!



## Online shop

[shop.wika.com](http://shop.wika.com)

Easy, quick and safe:  
Directly select the right product for you from our standard product portfolio. Or adapt the instrument you want exactly to your requirements with our configurator.



## Blog

[blog.wika.com](http://blog.wika.com)

In our blog, you can expect many interesting articles on the theme of measurement technology. Furthermore, there are various insights into the world of the WIKA Group.



## WIKA on LinkedIn

[linkedin.com/company/wikagroup](https://www.linkedin.com/company/wikagroup)

Follow us on LinkedIn. Don't just follow our news on products and applications, but also on important events within the WIKA Group.



## WIKA on YouTube

[youtube.com/wikagroup](https://www.youtube.com/wikagroup)

We are happy to welcome you to our YouTube channel. Here we don't just promote our company, but also present complex technical contents, explained in a simple and understandable way.



## WIKA on Instagram

[instagram.com/careeratwika/](https://www.instagram.com/careeratwika/)

Follow us on Instagram to stay up to date on exciting career opportunities, events, lotteries and much more.

### Notes on the use of registered trademarks

- LoRaWAN® is a trademark used under licence from LoRa Alliance®.
  - The Bluetooth® word mark and logos are registered trademarks owned by Bluetooth SIG, Inc. and any use of such marks by WIKA is under licence.
  - mioty® is a registered trademark of Fraunhofer IIS.
  - VARIVENT® is a registered trademark of the company GEA.
  - BioConnect® is a registered trademark of the company NEUMO.
- Other brands and trademarks are the property of their respective owners.

# WIKA worldwide

## Europe

### Austria

WIKÄ MessgerÄtevertrieb  
Ursula Wiegand GmbH & Co. KG  
Tel. +31 475 535500  
info@wika.at / www.wika.at

### Benelux

WIKÄ Benelux  
Tel. +31 475 535500  
info@wika.nl / www.wika.nl

### Bulgaria

WIKÄ Bulgaria EOOD  
Tel. +359 2 82198-10  
info@wika.bg / www.wika.bg

### Croatia

WIKÄ Croatia d.o.o.  
Tel. +385 1 6531-034  
info@wika.hr / www.wika.hr

### Denmark

WIKÄ Danmark A/S  
Tel. +45 4581 9600  
info@wika.as / www.wika.as

### Finland

WIKÄ Finland Oy  
Tel. +358 9 682492-0  
info@wika.fi / www.wika.fi

### France

WIKÄ Instruments s.a.r.l.  
Tel. +33 1 71 68 10 00  
info@wika.fr / www.wika.fr

### Germany

WIKÄ Alexander Wiegand SE & Co. KG  
Tel. +49 9372 132-0  
info@wika.de / www.wika.de

### Ireland

WIKÄ Instruments Ireland Limited  
Tel. +35 386 1449 360  
info@wika.ie / www.wika.co.uk

### Italy

WIKÄ Italia S.r.l. & C. S.a.s.  
Tel. +39 02 93861-1  
info@wika.it / www.wika.it

### Poland

WIKÄ Polska spólka z ograniczonÄ  
odpowiedzialnoœciÄ sp. k.  
Tel. +48 54 230110-0  
info@wikapolska.pl  
www.wikapolska.pl

### Romania

WIKÄ Instruments Romania S.R.L.  
Tel. +40 21 4048327  
info@wika.ro / www.wika.ro

### Russia

AO "WIKÄ MERA"  
Tel. +7 495-648018-0  
info@wika.ru / www.wika.ru

### Serbia

WIKÄ Merna Tehnika d.o.o.  
Tel. +381 11 2763722  
info@wika.rs / www.wika.rs

### Spain

Instrumentos WIKÄ S.A.U.  
Tel. +34 933 9386-30  
ventas@wika.es / www.wika.es

### Switzerland

WIKÄ Schweiz AG  
Tel. +41 41 91972-72  
info@wika.ch / www.wika.ch

### Türkiye

WIKÄ Instruments  
Endüstriyel Ölçüm Cihazları Tic. Ltd. Şti.  
Tel. +90 216 41590-66  
info@wika.com.tr  
www.wika.com.tr

### Ukraine

TOV WIKÄ Prylad  
Tel. +38 044 496 83 80  
info@wika.ua / www.wika.ua

### United Kingdom

WIKÄ Instruments Ltd  
Tel. +44 1737 644-008  
info@wika.co.uk / www.wika.co.uk

## North America

### Canada

WIKÄ Instruments Ltd.  
Tel. +1 780 4637035  
info@wika.ca / www.wika.ca

### USA

WIKÄ Instrument, LP  
Tel. +1 770 5138200  
info@wika.com / www.wika.us

### Gayesco-WIKÄ USA, LP

Tel. +1 713 4750022  
info@wikahouston.com  
www.wika.us

### Mensor Corporation

Tel. +1 512 3964200  
sales@mensor.com  
www.mensor.com

## Latin America

### Argentina

WIKÄ Argentina S.A.  
Tel. +54 11 5442 0000  
ventas@wika.com.ar  
www.wika.com.ar

### Brazil

WIKÄ do Brasil Ind. e Com. Ltda.  
Tel. +55 15 3459-9700  
vendas@wika.com.br  
www.wika.com.br

### Chile

WIKÄ Chile S.p.A.  
Tel. +56 9 4279 0308  
info@wika.cl / www.wika.cl

### Colombia

Instrumentos WIKÄ Colombia S.A.S.  
Tel. +57 601 7021347  
info@wika.co / www.wika.co

### Mexico

Instrumentos WIKÄ Mexico S.A. de C.V.  
Tel. +52 55 50205300  
ventas@wika.com / www.wika.mx

## Asia

### China

WIKÄ Instrumentation Suzhou Co., Ltd.  
Tel. +86 512 6878 8000  
info@wika.cn / www.wika.com.cn

### India

WIKÄ Instruments India Pvt. Ltd.  
Tel. +1800-123-101010  
info@wika.co.in / www.wika.com.in

### Japan

WIKÄ Japan K. K.  
Tel. +81 3 5439-6673  
info@wika.co.jp / www.wika.co.jp

### Kazakhstan

TOO WIKÄ Kazakhstan  
Tel. +7 727 225 9444  
info@wika.kz / www.wika.kz

### Korea

WIKÄ Korea Ltd.  
Tel. +82 2 869-0505  
info@wika.co.kr / www.wika.co.kr

### Malaysia

WIKÄ Instrumentation (M) Sdn. Bhd.  
Tel. +60 3 5590 6666  
info@wika.my / www.wika.my

### Philippines

WIKÄ Instruments Philippines Inc.  
Tel. +63 2 234-1270  
info@wika.ph / www.wika.ph

### Singapore

WIKÄ Instrumentation Pte. Ltd.  
Tel. +65 6844 5506  
info@wika.sg / www.wika.sg

### Taiwan

WIKÄ Instrumentation Taiwan Ltd.  
Tel. +886 3 420 6052  
info@wika.tw / www.wika.tw

### Thailand

WIKÄ Instrumentation Corporation  
(Thailand) Co., Ltd.  
Tel. +66 2 326 6876  
info@wika.co.th / www.wika.co.th

### Uzbekistan

WIKÄ Instrumentation FE LLC  
Tel. +998 71 205 84 30  
info@wika.uz / www.wika.uz

## Africa/Middle East

### Botswana

WIKÄ Instruments Botswana (Pty.) Ltd.  
Tel. +267 31 10013  
info@wika.co.bw / wika.co.bw

### Egypt

WIKÄ Near East Ltd.  
Tel. +20 2 240 13130  
info@wika.com.eg / www.wika.com.eg

### Namibia

WIKÄ Instruments Namibia Pty Ltd.  
Tel. +26 4 61238811  
info@wika.com.na / www.wika.com.na

### Nigeria

WIKÄ WEST AFRICA LIMITED  
Tel. +234 17130019  
info@wika.com.ng / www.wika.ng

### Saudi Arabia

WIKÄ Saudi Arabia Llc  
Tel. +966 53 555 0874  
info@wika.sa / www.wika.sa

### South Africa

WIKÄ Instruments Pty. Ltd.  
Tel. +27 11 62100-00  
sales@wika.co.za / www.wika.co.za

### United Arab Emirates

WIKÄ Middle East FZE  
Tel. +971 4 883-9090  
info@wika.ae / www.wika.ae

## Australia

### Australia

WIKÄ Australia Pty. Ltd.  
Tel. +61 2 88455222  
sales@wika.com.au / www.wika.com.au

### New Zealand

WIKÄ Instruments Limited  
Tel. +64 9 8479020  
info@wika.co.nz / www.wika.co.nz

**WIKÄ Alexander Wiegand SE & Co. KG**  
Alexander-Wiegand-Straße 30 | 63911 Klingenberg | Germany  
Tel. +49 9372 132-0 | info@wika.de | www.wika.de

12393852 03/2024 EN



You can find further  
information here!



Smart in sensing

www.wika.com