

Tension link

With thin-film technology from 5 kN

Models F7301 standard, F73C1 ATEX, F73S1 safety version

WIKA data sheet FO 51.19



For further approvals
see page 4

Applications

- Crawler cranes, mobile cranes, harbour cranes, for recording load and torque
- Conveyor systems
- Drives and winches
- Cable winch measurement
- Ship-lifting facilities

Special features

- Measurement ranges from 0 ... 5 kN [0 ... 1,124 lbf]
- Fine-grained structural steel with high-quality surface protection or corrosion-resistant stainless steel version
- High long-term stability, high shock and vibration resistance, excellent reproducibility
- For dynamic and static measurements
- Redundant output signal is possible



Fig. above: Tension link, model F7301

Fig. below: Tension link, model F73C1

Description

Tension links are designed for static and dynamic measurement tasks in the direct flux of force. As a load-bearing component in existing constructions, they determine the tension forces in a wide scope of applications.

Tension links of these models are often used in hoist and crane systems as torque support or rope fix point for load measurements. Further application areas are special machine constructions, e. g. in polymer processing machines.

Appropriate technical and regional approvals are available as an option.

The tension links of the model F73x1 are either made of high-strength, corrosion-resistant stainless steel 1.4542 or robust fine-grained steel with surface protection. Due to their properties, these materials are particularly suitable for the applications of tension links.

As output signals, the common active current and voltage outputs are available (4 ... 20 mA, 0 ... 10 V). Redundant output signals and CANopen® protocols are also possible.

These force transducers can be integrated into a certified WIKA overload protection with model ELMS1 (DIN EN ISO 13849-1 with PL d/cat. 3).

Technical data in accordance with VDI/VDE/DKD 2638

Models	F7301 and F73C1 with UL	F73S1
Rated force F_{nom} kN [lbf]	≥ 5 [$\geq 1,124$]	
Relative linearity error $d_{lin}^{1)}$	$\pm 0.5\% F_{nom}$	
Relative repeatability error in unchanged mounting position b_{rg}	$\pm 0.5\% F_{nom}$	
Temperature effect on		
characteristic value TK_c	0.2 % $F_{nom}/10$ K	
zero signal TK_0	0.2 % $F_{nom}/10$ K	
Force limit F_L	150 % F_{nom}	
Breaking force F_B	300 % F_{nom}	
Shear force influence d_Q (Signal with 100 % F_{nom} under 90° ²⁾)	$\pm 2\% F_{nom}$	
Rated displacement (typ.) s_{nom}	< 0.1 mm [< 0.004 in]	
Material of measuring device	<ul style="list-style-type: none"> ■ Corrosion-resistant stainless steel, 1.4542, ultrasound-tested 3,1 material ■ Version with 3,2 material available 	
Rated temperature $B_{T, nom}$	-20 ... +80 °C [-4 ... +176 °F]	
Operating temperature $B_{T, G}$	-30 ... +80 °C [-22 ... +176 °F]	-30 ... +80 °C [-22 ... +176 °F]
Storage temperature $B_{T, S}$	-40 ... +85 °C [-40 ... +185 °F]	
Electrical connection	<ul style="list-style-type: none"> ■ Circular connector M 12 x 1, 4-pin or 5-pin ■ CANopen® Circular connector M 12 x 1, 5-pin ■ MIL connector 	<ul style="list-style-type: none"> ■ 2-circular connector M 12x1, 4-pin ■ MIL connector
Output signal (rated output) C_{nom}	<ul style="list-style-type: none"> ■ 4 ... 20 mA, 2-wire, ■ 4 ... 20 mA, 3-wire ■ 2 x 4 ... 20 mA, redundant ■ DC 0 ... 10 V, 3-wire ■ DC 2 x 0 ... 10 V redundant ■ Signal jump ■ 4 ... 16 mA, 2-wire⁵⁾ ■ DC 2 ... 8 V, 3-wire⁵⁾ ■ CANopen® <p>Protocol in accordance with CiA®301, device profile CiA®404, communication services LSS (CiA®305), configuration of the instrument address and baud rate Sync/Async, Node/Lifeguarding, heartbeat; zero and span $\pm 10\%$ adjustable via entries in the object directory³⁾</p>	<p>Redundant opposing 4 ... 20 mA/ 20 ... 4 mA</p> <p>Version in accordance with requirements for functional safety per machinery directive 2006/42/EC as WIKA overload protection with model ELMS1 (DIN EN ISO 13849-1 with PL d/cat. 3).</p>
Current consumption	<ul style="list-style-type: none"> ■ Current output 4 ... 20 mA, 2-wire: signal current ■ Current output 4 ... 20 mA, 3-wire: < 8 mA ■ Voltage output: < 8 mA ■ CANopen®: < 1 W 	Current output 4 ... 20 mA, 2-wire: signal current
Supply voltage UB	<ul style="list-style-type: none"> ■ DC 9 ... 36 V for current output ■ DC 13 ... 36 V for voltage output ■ DC 9 ... 36 V for CANopen® 	DC 10 ... 30 V for current output
Burden	<ul style="list-style-type: none"> ■ $\leq (UB - 10 V) / 0.024 A$ for current output ■ $> 10 k\Omega$ for voltage output 	<ul style="list-style-type: none"> ■ $\leq (UB - 10 V) / 0.020 A$ (channel 1) for current output ■ $\leq (UB - 7 V) / 0.020 A$ (channel 2) for current output
Response time	≤ 2 ms (within 10 ... 90 % F_{nom}) ⁴⁾	
Protection (per EN/IEC 60529)		
Unplugged condition	IP66, IP67	IP67
Plugged condition	IP68, IP69, IP69K	
Electrical protection	Reverse voltage, overvoltage and short-circuit protection	
Vibration resistance	20 g, 100 h, 50...150 Hz (acc. to DIN EN 60068-2-6)	
Shock resistance	In accordance with DIN EN 60068-2-27	
Immunity	<ul style="list-style-type: none"> ■ In accordance with DIN EN 61326-1/DIN EN 61326-2-3 ■ EMC-strengthened version 	

1) Relative linearity error is specified in accordance with Directive VDI/VDE/DKD 2638 chapter 3.2.6

2) This value can result if 100 % F_{nom} acts at 90° to the axis.

3) Protocol in accordance with CiA®301, device profile CiA®404, communication service LSS (CiA®305)

4) Further response times possible on request.

5) Further signal jumps are realisable on request.

CANopen® and CiA® are registered community trademarks of CAN® in Automation e. V.

Technical data in accordance with VDI/VDE/DKD 2638

Models	F73C1 ATEX/IECEX EX ib ¹⁾
Rated force F_{nom} kN [lbf]	≥ 5 [$\geq 1,124$]
Relative linearity error d_{lin} ²⁾	$\pm 0.5\% F_{nom}$
Relative repeatability error in unchanged mounting position b_{rg}	$\pm 0.5\% F_{nom}$
Temperature effect on	
characteristic value TK_c	$0.2\% F_{nom}/10\text{ K}$
zero signal TK_0	$0.2\% F_{nom}/10\text{ K}$
Force limit F_L	$150\% F_{nom}$
Breaking force F_B	$300\% F_{nom}$
Shear force influence d_Q (Signal with 100% F_{nom} under 90°) ³⁾	$\pm 2\% F_{nom}$
Rated displacement (typ.) s_{nom}	$< 0.1\text{ mm}$ [$< 0.004\text{ in}$]
Material of measuring device	<ul style="list-style-type: none"> ■ Corrosion-resistant stainless steel, 1.4542, ultrasound-tested 3,1 material ■ Version with 3,2 material available
Rated temperature $B_{T, nom}$	$-20 \dots +80\text{ °C}$ [$-4 \dots +176\text{ °F}$]
Operating temperature $B_{T, G}$	Ex II 2G Ex ib IIC T4 Gb $-25\text{ °C} < Tamb < +85\text{ °C}$ Ex II 2G Ex ib IIC T3 Gb $-25\text{ °C} < Tamb < +100\text{ °C}$ Ex I M2 Ex ib I Mb $-25\text{ °C} < Tamb < +85\text{ °C}$ Ex II 2G Ex ib IIC T4 Gb $-40\text{ °C} < Tamb < +85\text{ °C}$ Ex I M2 Ex ib I Mb
Storage temperature $B_{T, S}$	$-40 \dots +85\text{ °C}$ [$-40 \dots +185\text{ °F}$]
Electrical connection	<ul style="list-style-type: none"> ■ Circular connector M 12x1, 4-pin ■ MIL connector ■ Cable gland
Output signal (rated output) C_{nom}	4 ... 20 mA, 2-wire
Current consumption	Current output 4 ... 20 mA 2-wire: signal current
Supply voltage UB	DC 10 ... 30 V for current output
Burden	<ul style="list-style-type: none"> ■ $< (UB - 10\text{ V}) / 0,024\text{ A}$ for current output ■ $> 10\text{ k}\Omega$ for voltage output
Response time	$\leq 2\text{ ms}$ (within 10 ... 90% F_{nom}) ⁴⁾
Protection (acc. to EN/IEC 60529)	IP67
Electrical protection	Reverse voltage, overvoltage and short-circuit protection
Shock resistance	20 g, 100 h, 50...150 Hz acc. to DIN EN 60068-2-6
Immunity	<ul style="list-style-type: none"> ■ In accordance with DIN EN 61326-1/DIN EN 61326-2-3 ■ EMC-strengthened version

1) The load pin with ignition protection type "ib" should only be powered using galvanically isolated repeater power supplies. Suitable repeater power supplies can be offered as an option, e.g. order number: 14255084.

2) Relative linearity error is specified in accordance with Directive VDI/VDE/DKD 2638 chapter 3.2.6.





3) This value can result if 100% F_{nom} acts at 90° to the axis.

4) Further response times possible on request.

Approvals

Logo	Description	Region
	EU declaration of conformity EMC directive	European Union

Optional approvals

Logo	Description	Region
	ATEX directive ¹⁾ per EN 60079-0:2012 and EN 60079-11:2012 (Ex ib) Hazardous areas Ex ib Ex II 2G Ex ib IIC T4 Gb $-25\text{ °C} < T_{\text{amb}} < +85\text{ °C}$ Ex II 2G Ex ib IIC T3 Gb $-25\text{ °C} < T_{\text{amb}} < +100\text{ °C}$ Ex I M2 Ex ib I Mb ³⁾ $-25\text{ °C} < T_{\text{amb}} < +85\text{ °C}$ Ex II 2G Ex ib IIC T4 Gb $-40\text{ °C} < T_{\text{amb}} < +85\text{ °C}$	European Union
	IECEx ²⁾ per IEC 60079-0:2011 (Ed. 6) and IEC 60079-11:2011 (Ed. 6) (Ex ib) Hazardous areas Ex ib Ex ib IIC T4/T3 Gb $-25\text{ °C} < T_{\text{amb}} < +85\text{ °C}$ Ex ib IIC T4 Gb $-25\text{ °C} < T_{\text{amb}} < +100\text{ °C}$ Ex ib I Mb ³⁾ $-25\text{ °C} < T_{\text{amb}} < +85\text{ °C}$ Ex ib IIC T4 Gb $-40\text{ °C} < T_{\text{amb}} < +85\text{ °C}$	International
	UL ²⁾ per UL 61010-1 and CSA C22.2 Number 61010-1 Component approval	USA and Canada
	EAC EMC directive	Eurasian Economic Community
	EAC Ex ¹⁾ Hazardous areas Ex ib Ex ib IIC T3 Gb $-40\text{ °C} < T_{\text{amb}} < +100\text{ °C}$ Ex ib IIC T3 Gb $-45\text{ °C} < T_{\text{amb}} < +100\text{ °C}$ Ex ib IIC T4 Gb $-40\text{ °C} < T_{\text{amb}} < +85\text{ °C}$ Ex ib IIC T4 Gb $-45\text{ °C} < T_{\text{amb}} < +100\text{ °C}$	Eurasian Economic Community

1) Only with models F73C1. ATEX equipment is labeled and certified under the brand tecsis.

2) Only models F7301 and F73C1 with UL approval.

3) Only possible with cable gland.

→ For approvals and certificates, see website.

Dimensions/Mounting situation

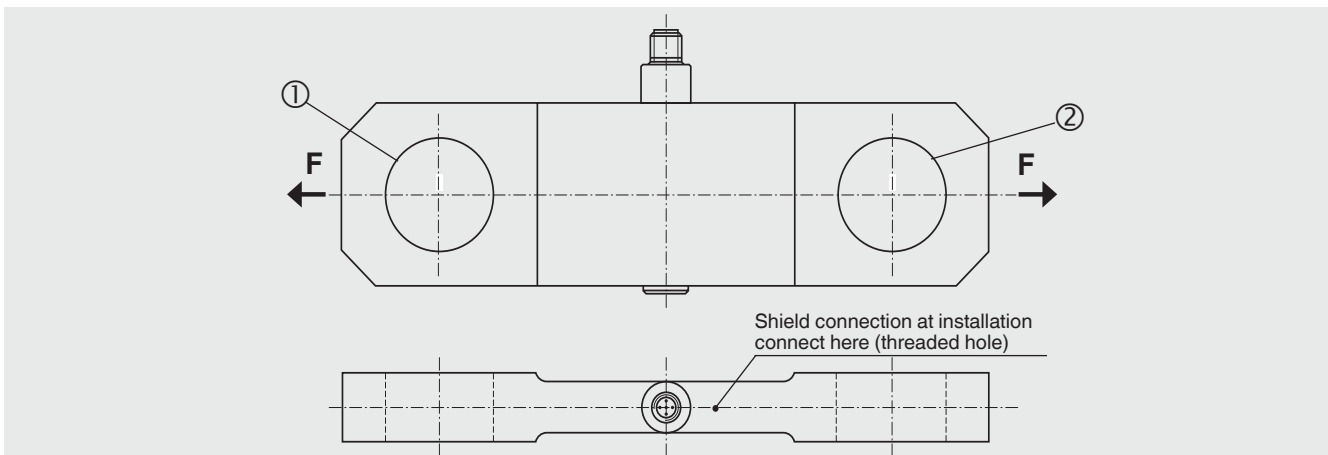

Dimensions: The customer-specific load pin drawing of the respective order number has priority.

Insert the corresponding bolts into the corresponding holes ① and ② on both sides. Load the tension link with tension force (F).

Pin assignment of analogue output

Abbreviations, definitions

Signal	Description
UB	Voltage source for sensor
UB+	Sensor-supply voltage (+)
UB-	Sensor-supply voltage (-)
S+	Output signal (+)
S-	Output signal (-)
0 V	0 V potential

Signal	Description
(A)	Ammeter
(V)	Voltmeter
(+)	Voltage source
⌋	Switch
(⊕)	Shield (grounding)

For models F7301 and F73C1 with UL approval

Output 4 ... 20 mA, 2-wire

Connector M12 x 1, 5-pin

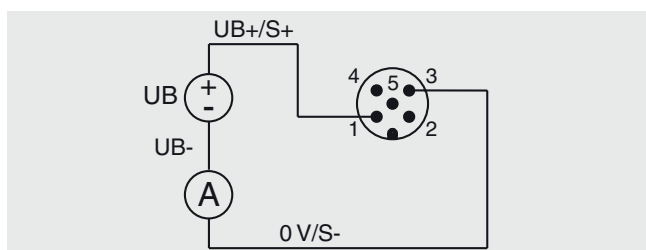

Signal	4 ... 20 mA, 2-wire	Cable colour
UB+/S+	1	Brown
0 V/S-	3	Black
Shield (⊕)	Case/connector	-

Cable colours are only valid when using the standard WIKA cable, e.g. order number: 14259454

Output 4 ... 20 mA, 3-wire

Connector M12 x 1, 5-pin

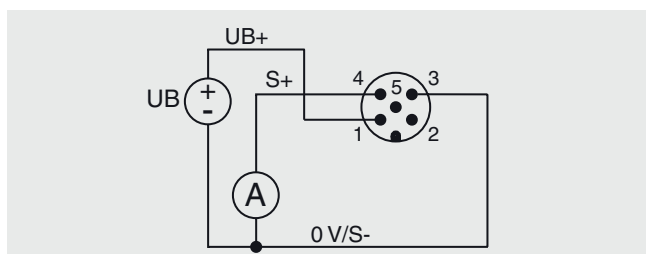

Signal	4 ... 20 mA, 3-wire	Cable colour
UB+	1	Brown
S+	4	Black
0 V/S-	3	Blue
Shield (⊕)	Case/connector	-

Cable colours are only valid when using the standard WIKA cable, e.g. order number: 14259454

Output 0 ... 10 V, 3-wire

Connector M12 x 1, 5-pin

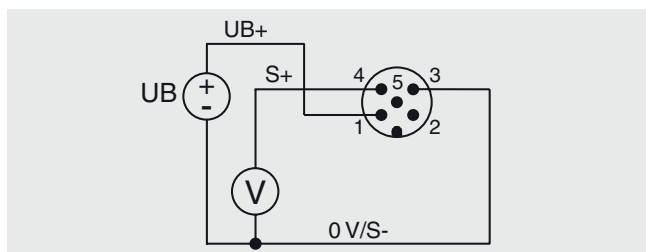

Signal	0 ... 10 V, 3-wire	Cable colour
UB+	1	Brown
S+	4	Black
0 V/S-	3	Blue
Shield (⊕)	Case/connector	-

Cable colours are only valid when using the standard WIKA cable, e.g. order number: 14259454

For models F73C1 for ATEX

Output 4 ... 20 mA, 2-wire for ATEX Ex ib

Connector M12 x 1, 4-pin

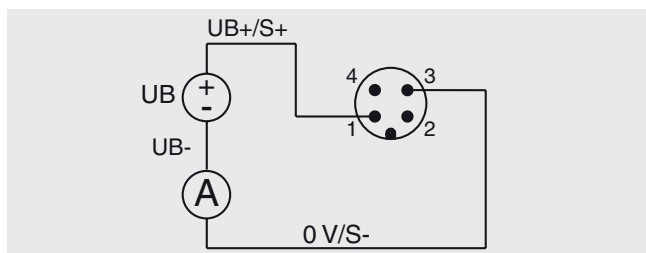

Signal	ATEX/IECEx Ex ib 4 ... 20 mA, 2-wire	Cable colour
UB+/S+	1	Brown
0 V/S-	3	Blue
Shield (⊕)	Case/connector	-

Cable colours are only valid when using the standard WIKA cable, e.g. order number: 14259454

Pin assignment with signal jump

Abbreviations, definitions

Signal	Description
UB	Voltage source for sensor
UB+	Sensor-supply voltage (+)
UB-	Sensor-supply voltage (-)
UR	Voltage source for den signal jump
UR+	Signal jump-supply voltage (+)
UR-	Signal jump-supply voltage (-)
S+	Output signal (+)
S-	Output signal (-)
0 V	0 V potential

Signal	Description
(A)	Ammeter
(V)	Voltmeter
(+)	Voltage source
— —	Switch
(⊕)	Shield (grounding)

For model F7301 with signal jump

Output 4 ... 20 mA, 2-wire

Circular connector M12 x 1, 4-pin

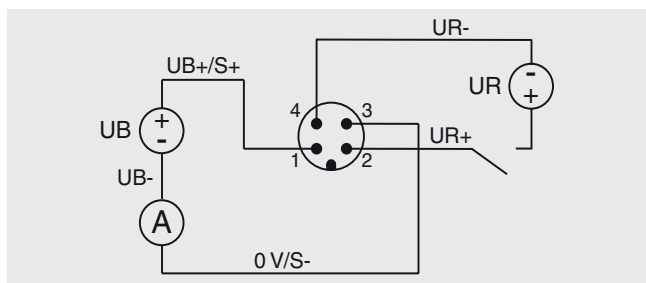

Signal	4 ... 20 mA, 2-wire	Cable colour
UB+/S+	1	Brown
0 V/S-	3	Blue
UR+	2	White
UR-	4	Black
Shield (⊕)	Case/connector	-

Cable colours are only valid when using the standard WIKA cable, e.g. order number: 14259454

Output 4 ... 20 mA, 3-wire

Circular connector M12 x 1, 4-pin

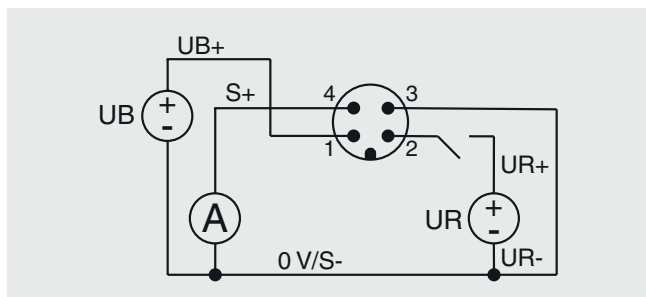

Signal	4 ... 20 mA, 3-wire	Cable colour
UB+	1	Brown
0 V/S-	3	Blue
UR+	2	White
UR-	3	Blue
S+	4	Black
Shield (⊕)	Case/connector	-

Cable colours are only valid when using the standard WIKA cable, e.g. order number: 14259454

Output 0 ... 10 V, 3-wire

Circular connector M12 x 1, 4-pin

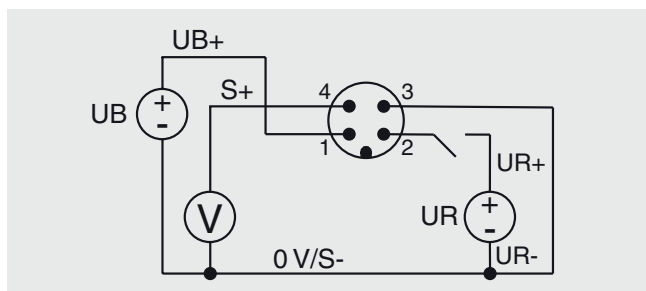

Signal	0 ... 10 V, 3-wire	Cable colour
UB+	1	Brown
0 V/S-	3	Blue
UR+	2	White
UR-	3	Blue
S+	4	Black
Shield (⊕)	Case/connector	-

Cable colours are only valid when using the standard WIKA cable, e.g. order number: 14259454

Pin assignment redundant with 1 x connector

Abbreviations, definitions

Signal	Description
UB	Voltage source for sensor
UB+	Sensor-supply voltage (+)
UB-	Sensor-supply voltage (-)
S+	Output signal (+)
S-	Output signal (-)
CH1	Channel 1
CH2	Channel 2
CH1+2	Channel 1 and channel 2
0 V	0 V potential

Signal	Description
Ⓐ	Ammeter
Ⓥ	Voltmeter
⊕	Voltage source
⎓	Switch
⊕	Shield (grounding)

For models F7301 and F73C1 with UL approval

Output 4 ... 20 mA, 2-wire

Circular connector M12 x 1, 5-pin

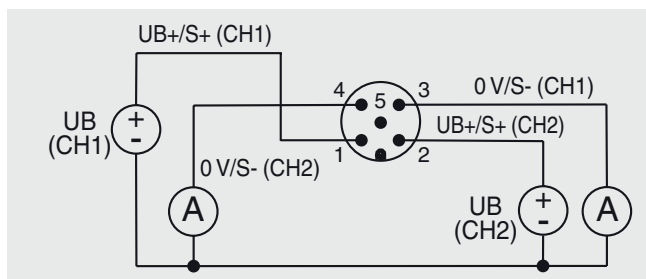

Signal	4 ... 20 mA, 2-wire	Cable colour
UB+/S+ (CH1)	1	Brown
UB+/S+ (CH2)	2	White
0 V/S- (CH1)	3	Blue
0 V/S- (CH2)	4	Black
Shield ⊕	Case/connector	-

Cable colours are only valid when using the standard WIKA cable, e.g. order number: 14259454

Output 4 ... 20 mA, 3-wire

Circular connector M12 x 1, 5-pin

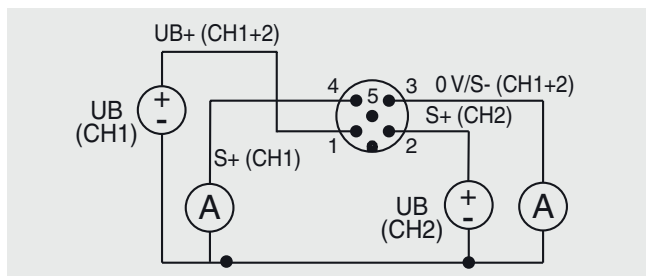

Signal	4 ... 20 mA, 3-wire	Cable colour
UB+ (CH1+2)	1	Brown
0 V/S- (CH1+2)	3	Blue
S+ (CH1)	4	Black
S+ (CH2)	2	White
Shield ⊕	Case/connector	-

Cable colours are only valid when using the standard WIKA cable, e.g. order number: 14259454

Output 0 ... 10 V, 3-wire

Circular connector M12 x 1, 5-pin

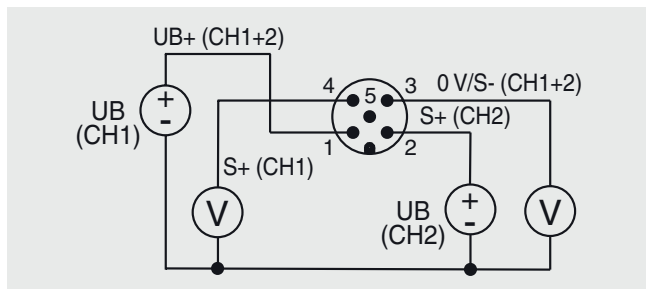

Signal	0 ... 10 V, 3-wire	Cable colour
UB+ (CH1+2)	1	Brown
0 V/S- (CH1+2)	3	Blue
S+ (CH1)	4	Black
S+ (CH2)	2	White
Shield ⊕	Case/connector	-

Cable colours are only valid when using the standard WIKA cable, e.g. order number: 14259454

Diverse redundant pin assignment, opposing, with 2 x connectors

Abbreviations, definitions

Signal	Description
UB	Voltage source for sensor
UB+	Sensor-supply voltage (+)
UB-	Sensor-supply voltage (-)
S+	Output signal (+)
S-	Output signal (-)
CH1	Channel 1
CH2	Channel 2
CH1+2	Channel 1 and channel 2
0 V	0 V potential

Signal	Description
(A)	Ammeter
(V)	Voltmeter
(+)	Voltage source
—	Switch
(⊕)	Shield (grounding)

For model F73S1

Output 4 ... 20 mA, 3-wire

Circular connector M12 x 1, 4-pin

Connector, channel 1

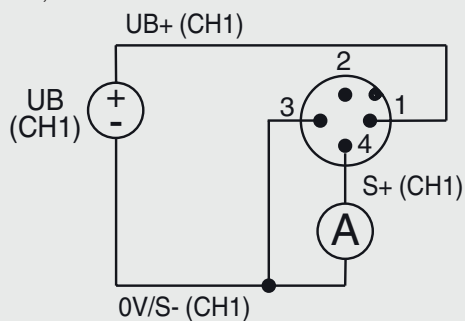

Connector, channel 2

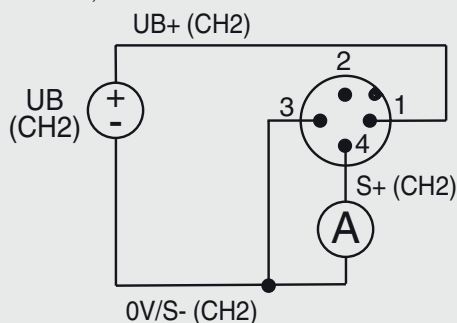

Circular connector M12 x 1, 4-pin

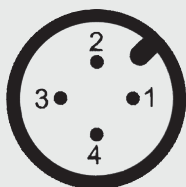

4 ... 20 mA, 3-wire diverse redundant opposing

Signal	Connector, channel 1	Connector, channel 2	Cable colour
UB+	1	1	Brown
0 V/S-	3	3	Blue
S+	4	4	Black
Shield (⊕)	Case/connector	Case/connector	-

Cable colours are only valid when using the standard WIKA cable, e.g. order number: 14259454

2-connector variant, e.g. in combination with ELMS1 overload protection (F73S1).

Version in accordance with requirements for functional safety per machinery directive 2006/42/EC.

Pin assignment for MIL connector

Abbreviations, definitions

Signal	Description
UB	Voltage source for the sensor
UB+	Sensor voltage supply (+)
UB-	Sensor voltage supply (-)
S+	Output signal (+)
S-	Output signal (-)
CH1	Channel 1
CH2	Channel 2
CH1+2	Channel 1 and channel 2
0 V	0 V potential

Signal	Description
(A)	Ammeter
(V)	Voltmeter
(+)	Voltage source
⌵	Switch
(⊕)	Shield [ground]

For the models F7301, F73C1 with UL, F73S1 and F73C1 Atex Ex ib

MIL connector - 1-channel

MIL-CA3102E 16S-1P-B

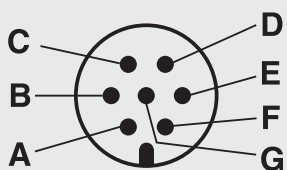

1-channel 4 ... 20 mA, 2-wire

Signal	Pin	Cable colour
UB+/S+	A	Brown
0 V/S-	C	Blue
Shield (⊕)	Cable gland	-

1-channel 4 ... 20 mA, 3-wire

Signal	Pin	Cable colour
UB+	A	Brown
0 V/S-	C	Blue
S+	D	Black
Shield (⊕)	Cable gland	-

1-channel 0 ... 10 V, 3-wire

Signal	Pin	Cable colour
UB+	A	Brown
0 V/S-	C	Blue
S+	D	Black
Shield (⊕)	Cable gland	-

Cable colours are only valid when using the standard WIKA cable, e.g. order number: 79100531

MIL connector - redundant

MIL-CA3102E 16S-1P-B

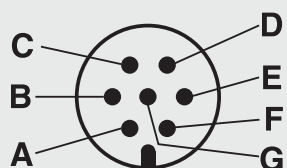

Redundant 4 ... 20 mA, 2-wire

Signal	Pin	Cable colour
UB+/S+ (CH1)	A	Brown
0 V/S- (CH1)	C	Blue
UB+/S+ (CH2)	D	White
0 V/S- (CH2)	F	Black
Shield (⊕)	Cable gland	-

Redundant 4 ... 20 mA, 3-wire

Signal	Pin	Cable colour
UB+ (CH1)	A	Brown
UB+ (CH2)	B	White
0 V/S- (CH1)	C	Green
S+ (CH1)	D	Yellow
0 V/S- (CH2)	E	Grey
S+ (CH2)	F	Pink
Shield (⊕)	Cable gland	-

Redundant 0 ... 10 V, 3-wire

Signal	Pin	Cable colour
UB+ (CH1)	A	Brown
UB+ (CH2)	B	White
0 V/S- (CH1)	C	Green
S+ (CH1)	D	Yellow
0 V/S- (CH2)	E	Grey
S+ (CH2)	F	Pink
Shield (⊕)	Cable gland	-

Cable colours are only valid when using the standard WIKA cable, e.g. order number: 79100531

Pin assignment for CANopen® in accordance with CiA®303-1

Abbreviations, definitions

Signal	Description
CAN-SHLD, shield 	Shield
CAN-V+	External positive voltage supply for the supply of the sensor
CAN-GND	External 0 V potential for the supply of the sensor
CAN-High	CAN_H bus line (dominant high)
CAN-Low	CAN_L bus line (dominant low)

For models F7301 and F73C1 with UL

CANopen® output

Circular connector M12 x 1, 5-pin

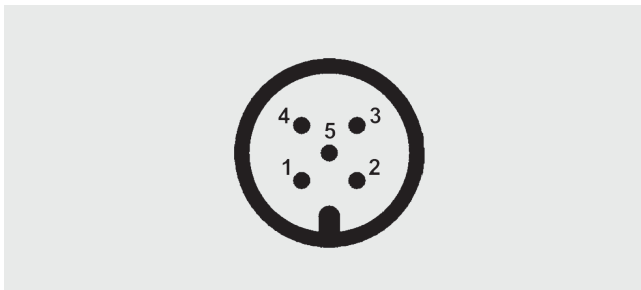

Signal	Pin	Cable colour
CAN-SHLD, shield 	1 / Case/connector	Brown
CAN-V+	2	Blue
CAN-GND	3	White
CAN-High	4	Blue
CAN-Low	5	Black

Cable colours are only valid when using the standard WIKA cable, e.g. order number: 14259454

CANopen® output with Y-connector

Socket M12 x 1, 5-pin / connector M12 x 1, 5-pin

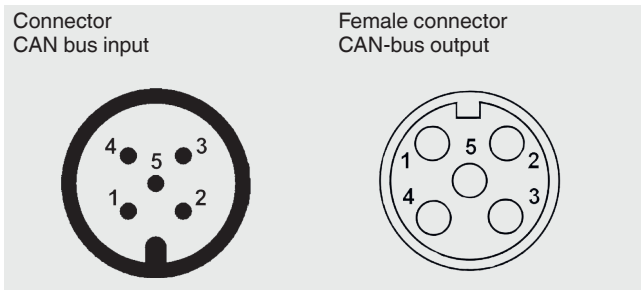

The socket and connector are connected internally.

Socket, M12 x 1, 5-pin / connector, M12 x 1, 5-pin		
Signal	Pin	Cable colour
CAN-SHLD, shield 	1 / Case/connector	Brown
CAN-V+	2	Blue
CAN-GND	3	White
CAN-High	4	Blue
CAN-Low	5	Black

Cable colours are only valid when using the standard WIKA cable, e.g. order number: 14259454

Short description of the signal jump electronics

Amplifier 4 ... 20 mA or 0 ... 10 V for signal jump applications with 2-channel computer control.

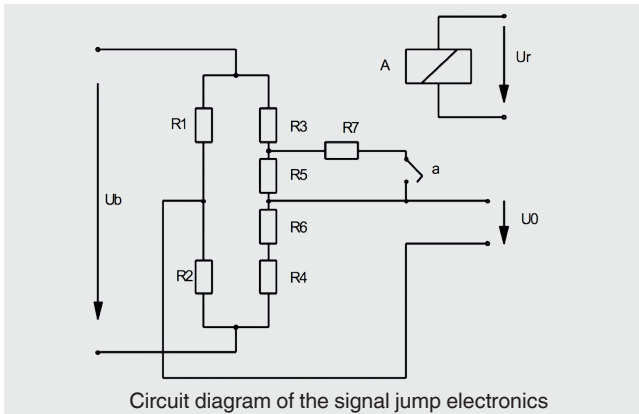

With these force transducers, four variable resistors (R1 ... R4) are connected together to form a Wheatstone bridge. When the measuring body deforms, the opposing resistors are stretched or compressed in the same way. This leads to a detuning of the bridge and a diagonal voltage U_0 .

The test resistor R7 is now important in connection with checking the subsequent amplifier circuit and the subsequent signal paths. This is switched parallel to the resistor R5 via the relay contact (a) as soon as the excitation voltage U_r of the relay A is present. The connection of the resistor R7 causes a defined, always constant, detuning of the zero point (diagonal voltage) of the Wheatstone bridge.

An external controller that is independent of the force transducer must monitor the safe functioning of the force transducer. The functional test with a signal jump of 4 mA / 2 V is executed at an interval of 24 hours. The controller activates the relay A, thus changing the output signal of the force transducer in a defined manner.

If the expected change in the output signal occurs, it can be assumed that the entire signal path from the Wheatstone bridge per the amplifier through to the output is functioning correctly. If no signal change occurs, then it can be concluded that there is an error in the signal path.

Furthermore, the measuring signal should be checked by the controller for min. (A) and max. (B) signal values in order to detect any cable breaks or short circuits that may occur.



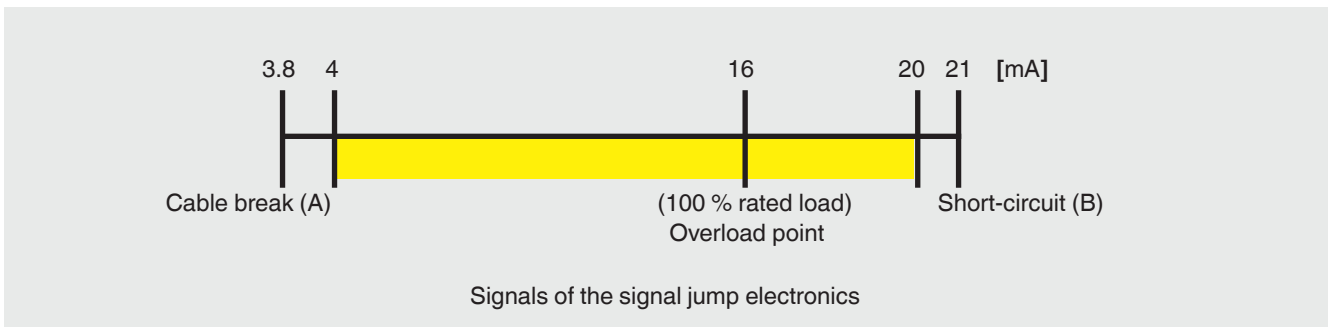

The default setting of the force transducers with a current output of 4 ... 20 mA for overload detection is, for example:



With a fixed signal jump of, for example, 4 mA, the test cycle can then be triggered, in any operating state, by activating the test relay. The upper measuring range limit of 20 mA will never be reached and thus the checking of the signal jump is enabled.

Accessories

Connectors model EZE53 with moulded cable

Model	Description	Temperature range	Cable diameter	Cable length	Order number
	Straight version, cut to length, 4-pin, PUR cable, UL listed, IP67	-20 ... +80 °C [-4 ... +176 °F]	Ø 4.75 mm ... 5.7 mm [Ø 0.18 in ... 0.22 in]	2 m [6.6 ft]	14259451
				5 m [16.4 ft]	14259453
				10 m [32.8 ft]	14259454
	Straight version, cut to length, 5-pin, PUR cable, UL listed, IP67	-20 ... +80 °C [-4 ... +176 °F]	Ø 4.75 mm ... 5.7 mm [Ø 0.18 in ... 0.22 in]	2 m [6.6 ft]	14259458
				5 m [16.4 ft]	79100672
				10 m [32.8 ft]	14259472
	Angled version, cut to length, 4-pin, PUR cable, UL listed, IP67	-20 ... +80 °C [-4 ... +176 °F]	Ø 5.05 mm ... 6 mm [Ø 0.2 in ... 0.24 in]	2 m [6.6 ft]	14259452
				5 m [16.4 ft]	14293481
				10 m [32.8 ft]	14259455
	Angled version, cut to length, 5-pin, PUR cable, UL listed, IP67	-20 ... +80 °C [-4 ... +176 °F]	Ø 5.05 mm ... 6 mm [Ø 0.2 in ... 0.24 in]	2 m [6.6 ft]	79101493
				5 m [16.4 ft]	79100686
				10 m [32.8 ft]	On request

Other cable lengths and cable types (e.g. for MIL connector) are available on request.

Repeater power supply

The analogue input signal is transmitted to the non-hazardous area as galvanically isolated current value. The input signal can be overlaid on the Ex or non-Ex sides with binary signals transmitted bidirectionally.

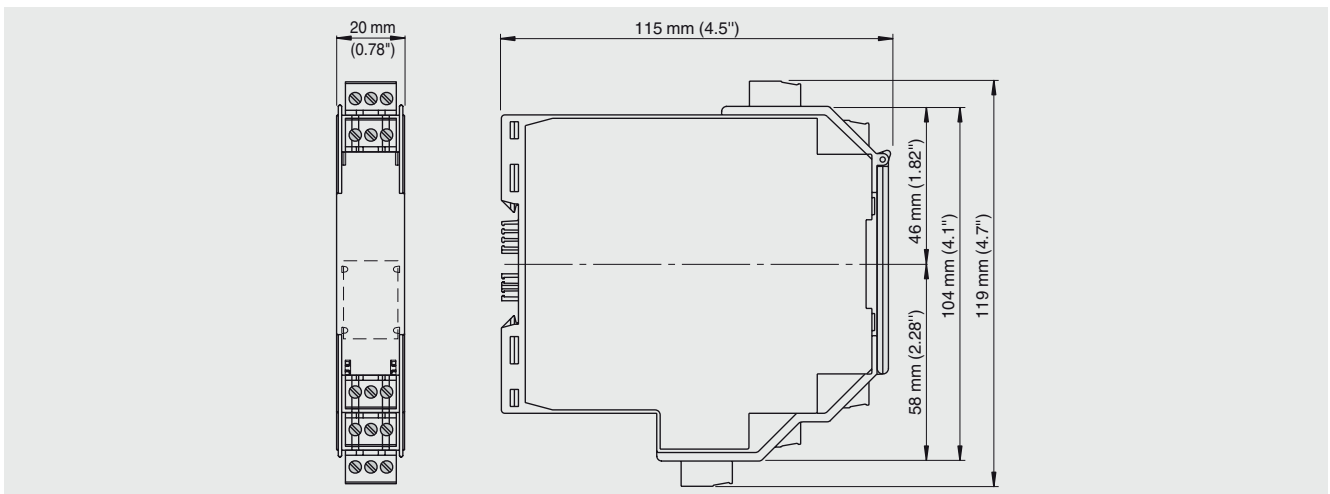

Repeater power supply	Order number
1-channel with DC 24 V supply	14255084

→ WIKA accessories can be found online at www.wika.com.

Ordering information

Model / Rated force / Relative linearity error / Temperature range / Output signal / Electrical connection / Approvals / Optional approvals, certificates / Pin assignment / Accessories

© 09/2021 WIKA Alexander Wiegand SE & Co. KG, all rights reserved.
The specifications given in this document represent the state of engineering at the time of publishing.
We reserve the right to make modifications to the specifications and materials.
In case of a different interpretation of the translated and the English data sheet, the English wording shall prevail.

